

DENTAL UNIT AND CHAIR

tbCOMPASS

OPERATING INSTRUCTIONS

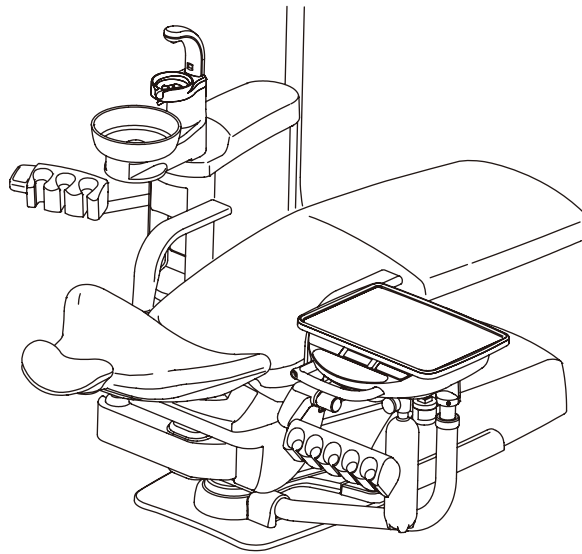

IMPORTANT

- **This manual provides operating instructions for the tbCOMPASS.**
- **The instructions contained in this booklet should be thoroughly read and understood before operating the unit and chair.**
- **After the installation has been completed, keep this manual in a safe place and refer to it for future maintenance.**
- **If you have any questions about this Manual or this product, please contact us. If manual becomes unreadable or is lost, please request a new manual by contacting your dealer.**
- **Installation should be conducted by authorized personnel only. Follow instructions on installation manual.**

 **Belmont**



Table of Contents

INTENDED USE OF THE PRODUCT	
SYMBOLS	
SAFETY PRECAUTIONS (Please observe safety precautions fully)	1 ~ 9
PRACTICE OF FLUSH OUT	10
OVERVIEW AND MAJOR COMPONENTS	11 ~ 13
DESCRIPTION OF OPERATION AND FUNCTIONS OF COMPONENTS	14 ~ 41

1 Chair Section

- Main Switch (Chair Section) 14
- Twin Articulating Headrest 14
- Single Articulating Headrest (optional) 15
- Foot Switch (optional) 15

2 Doctor Unit Section

- Main Switch (Unit Section) 17
- Handpiece 18
- Handpiece priority function (first priority) 18
- Handpiece air pressure gauge 18
- Description of doctor control panel 19
- Operation and display of micromotor 26
- Operation and display of scaler 26
- Table Height Adjustment 27
- Intra-oral size film viewer (optional) 27
- Panorama size film viewer (optional) 27
- Water tank (optional) 28

3 Foot Controller

- Foot Controller (SE Type) 28

4 Cuspidor Unit Section

- Maintenance panel and cuspidor control panel . . . 29
- Vacuum handpiece 31
- Saliva ejector handpiece 31
- Spittoon bowl Rotation 31
- Assistant control panel 31
- Height adjustable assistant arm (optional) . . . 32
- Sensor cupfiller (Optional) 32

5 Dental Light Section

- 701 dental light (Type AL-720PAS)(optional) 33
- 900 dental light (Type AL-920PAS)(optional) 34
- 300LED dental light (Type AL-320PAS)(optional) . . 35

6 Right/Left Handed Dentistry Conversion

- Confirm before convert 36
- Right/Left handed dentistry conversion 36
- Confirm the safety function 41

OPERATION SETTING	42 ~ 50
--------------------------	----------------

1 Chair Auto Operation Setting

- Preset position setup procedures 42
- Last position setup procedures 42

2 Doctor Unit Section

- Contents and sequence of function switch 43
- ① Dental timer 44
- ② Doctor number 45
- ③ Flushout 45
- ④ Key touch tone 46
- ⑤ Handpiece light switching-on timing 46
- ⑥ Alarm tone 47

- ⑦ Steps of micromotor limit rotation speed 47
- ⑧ Micromotor spray mode 47
- ⑨ Interlocked action of cupfiller and bowl flush . . 48
- Setup of micromotor preset mode 48
- Displaying the micromotor gear ratio 49
- Recurrence mode at the time of power on and setup . . 50
- Indicator off function 50
- Indicator abnormality and troubleshooting 50

OPERATION STOPPING FUNCTION	51
------------------------------------	-----------

- Chair motion stop function 51
- Handpiece rotation stop function 51

ADJUSTMENT OF PARTS	52
----------------------------	-----------

1 Junction Box Section

- Main air pressure reducing valve 52
- Main water pressure reducing valve 52

2 Doctor Unit Section

- Water adjustment of the handpiece spray 52
- Water/air adjustment of the syringe spray 52

CARE AND MAINTENANCE	53 ~ 62
-----------------------------	----------------

1 Chair Section

- Chair Surface Cleaning and Disinfection 53

2 Doctor Unit Section

- Tray mat (optional) 54
- Doctor control panel 54
- Doctor Instrument holder 55
- Cleaning of Handpiece hose 55
- Care and Maintenance of Handpiece hose . . . 55
- Oil mist separator (optional) 55

3 Cuspidor Unit Section

- Assistant control panel 56
- Assistant Instrument holder 56
- Cleaning of spittoon section 57
- Cleaning of vacuum / saliva ejector lines . . . 57
- Cleaning of vacuum / saliva ejector handpiece . . 58
- Sterilization of vacuum / saliva ejector handpiece . . 59
- Cleaning of the solid collector 60
- Cleaning of vacuum /saliva ejector hose 60
- Cleaning of Belmont 77 syringe 61
- Sterilization of Belmont 77 syringe 61

4 Junction Box Section

- Cleaning air filter drain valve and discharging water from air compressor 62

5 Product Exterior

- Cleaning and disinfection of product exterior . . 62

CARE STORAGE, LIFETIME, DISPOSAL AND RESTRICTIONS OF USE	63
---	-----------

BEFORE ASKING FOR REPAIRS	64
----------------------------------	-----------

DIMENSIONS AND SPECIFICATIONS	65 ~ 68
--------------------------------------	----------------

MAINTENANCE AND INSPECTION	69 ~ 71
-----------------------------------	----------------

LIST OF COMPATIBLE HANDPIECES	72
--------------------------------------	-----------

ELECTROMAGNETIC COMPATIBILITY (EMC)	73 ~ 74
--	----------------

DECLARATION OF CONFORMITY	75
----------------------------------	-----------

Intended Use of the Product

This product is an active therapeutic device intended for the exclusive use for diagnoses, treatments and relative procedures of dentistry.

The product must be operated or handled by the qualified dentists or by dental staffs under the supervision of the dentist.

Such dentists or dental staffs should instruct and/or assist the patients to approach to and leave from the product.

Patients should not be allowed to operate or handle the product unless he/she is so instructed.

The product is supplied together with the handpieces like electric micromotor, air turbine and/or motor, scaler and so on.

Compatibility of Handpieces

Use the compatible handpieces as shown on the attached list for this unit. (List of compatible handpieces).

Compliance with Directives

tbCOMPASS compliance with the following directives, Medical Device Directive 93/42/EEC, RoHS Directive 2011/65/EU.

Important Notes

In case of the troubles, please contact Takara Belmont offices or your dealers.

Do not disassemble or attempt to repair.

Disassembly, repair or modifications should only be done by a qualified repair technician.

Attempts at disassembly, repair or modifications may lead to abnormal operation and accidents.

Disposal of residue material

Please request a special contractor when you dispose amalgam.











































In case of disposal of equipment

When disposing the unit and chair, appropriately dispose complying with all current applicable regulations and local codes.

In EU area, EU directive 2002/96/EC on waste electrical and electronic equipment (WEEE) is applied on this product. In this directive, environment conscious recycling/abandonment is obligated.



SYMBOLS

In this manual, on the labels, on the control panels of tbCOMPASS, following symbols are used. Confirm the meaning of each symbol.







Symbol	Description	Symbol	Description	Symbol	Description	Symbol	Description
	ON (power)	○	OFF (power)	SN	Serial number		Syringe
	Fiber optic handpiece light on/off		Rotation mode select		Handpiece coolant spray on/off		Micro motor Forward/Reverse select
	To raise the chair		To lower the chair		To Recline the backrest		To raise the backrest
	Chair manual control		Handpiece Setting	F	Function switch		Store switch
— min.	Minus	+ sec.	Plus		Chair auto control		Chair manual control
LP	Chair last position	0	Chair auto return	1	Chair preset1	2	Chair preset2
	To raise the chair		To lower the chair		To Recline the backrest		To raise the backrest
	To raise the chair		To lower the chair		To Recline the backrest		To raise the backrest
	Bowl flush		Cupfiller		Dental light on/off	W	Water
A	Air		Dental light mode selection		Service outlet (air)		Service outlet (water)
	Service outlet water flow control		Water heater		Authorized representative in the European community		Manufacturer
	Date of manufacture		Protective earth (ground)		Type B Applied Parts		Comply with MDD,93/42/EEC
~	Alternating current		Functional earth (ground)	SN	Serial Number	REF	Reference number
	General warning, unspecified *The base color is yellow in the actual label.		Basic precaution, unspecified *The base color is yellow in the actual label.		Refer to instruction manual/booklet *The color of black part is blue in the actual label.		
	Autoclave Symbol This symbol on component means that the component can be sterilised with an autoclave at 135°C max.				Separate collection for electrical and electronic equipment		







SAFETY PRECAUTIONS (Please observe safety precautions fully)

- Before use, read the “Safety precautions” carefully to ensure proper use.
- The following information is designed to ensure safe use of this product and to prevent injury and damage to you and others. The precautions contained here are classified depending on the severity and degree of imminence of possible injury or damage resulting from improper use. Be sure to follow all the information, which is important for safety.

Classification of precautions	Severity and degree of imminence of possible injury or damage
 WARNING	This symbol indicates that “ignorance of these precautions may lead to severe injury or even death as a result of improper use.”
 CAUTION	This symbol indicates that “ignorance of these precautions may lead to mild or moderate physical injury or damage to property as a result of improper use.”
NOTICE	This symbol indicates that “it is recommended to follow these precautions for safety.”















The following symbols are used to explain the precautions.

Warning Symbols	Prohibition Symbols	Forcing Direction Symbols
 Caution Fire  Caution electrical shock  Caution Hot surface	 General prohibition sign  Prohibit disassemble / repair	 General sign  Earth / ground sign

 WARNING	
	1. Be sure to turn off breakers for equipment in the clinic when this product will not be used for a long period of time
	Be sure to turn off breakers for equipment in the clinic when this product will not be used for a long period of time (following the completion of work, during the suspension of business, etc.). Insulation degradation may cause electrical fire.
	2. Be sure to turn off the main switch upon completion of work or during work breaks
	Be sure to turn off the main switch upon completion of work or during work breaks. This prevents incorrect operation due to accidental contact and associated hazards.
	3. Never disassemble, repair or modify this product
	Individuals other than certified repair technicians should not disassemble or attempt to repair and modify this product. This could lead to an accident, failure, electric shock or fire.













SAFETY PRECAUTIONS (Please observe safety precautions fully)

WARNING

 	<p>4. Be sure to establish a grounding connection</p> <p>Be sure to establish a proper grounding connection. (Refer to a vendor for grounding connection.) Failure or electric leakage may lead to electric shock.</p>
	<p>5. Use with caution in the presence of electromagnetic interference waves</p> <p>Do not place this product around equipment generating electromagnetic waves (including communications equipment, elevators, etc.) as incorrect operation of this product may occur in the presence of electromagnetic interference waves. Do not use equipment generating electromagnetic waves, such as mobile phones, around this product.</p>
	<p>6. Do not sit on other than seat</p> <p>When the backrest is at the forward position, do not sit on or place an undue load on the headrest or legrest of dental chair. This could cause the unit to topple or could damage the unit.</p>
	<p>7. Do not place an undue load on the arm</p> <p>Do not get on or place an undue load on the arm of this unit or dental chair armrest. This could cause the unit to topple or other accidents.</p>
	<p>8. Immediately wipe off any water spills or leakage on the floor</p> <p>Immediately wipe off any water spills or leakage on the floor. Decreased strength of the floor may lead to physical injury including fall, or property damage.</p>
	<p>9. Be sure to turn off the main switch when electrocautery is in use</p> <p>Be sure to turn off the main switch when electrocautery is in use, because noise may cause incorrect operation of this product.</p>
	<p>10. Use with caution on patients with a cardiac pacemaker</p> <p>Use this product with extreme caution on patients with a cardiac pacemaker. In the case of any abnormalities in patients during use, immediately turn off this product and discontinue use.</p>
	<p>11. Ensure the maintenance of this product</p> <ul style="list-style-type: none"> • Failure to maintain this product may lead to physical injury or property damage. • Refer to the section of maintenance.
 	<p>12. Be sure to use the mirror cover</p> <ul style="list-style-type: none"> • Be sure to use the mirror cover of the dental light when the light is turned on. Direct contact with lamps may cause burns. • See the Instruction Manual of the dental light for further information.
  	<p>13. Be sure to turn off the power when replacing lamps</p> <ul style="list-style-type: none"> • Be sure to turn off the power when replacing the dental light. This could result in electric shock. • Use only dedicated halogen lamps. • Immediately after a halogen lamp has burnt out, the lamp and the lamp holder are still hot. Replace the lamp after they cool down. • Do not touch halogen lamps with bare hands. • See the Instruction Manual of the dental light for further information.
	<p>14. Do not place objects weighing 3 kg or more on the Doctor's table</p> <p>Do not place objects weighing three kilograms or more on the Doctor's table. This could cause damage to the Doctor's table, defective function or accidents.</p>















SAFETY PRECAUTIONS (Please observe safety precautions fully)

WARNING

  	<p>15. When water leaking from the unit</p> <p>In the case of water leaking from the unit, discontinue use, turn off the water main valve, main switch, breaker and contact the dealer or our company.</p>
 	<p>16. Be careful not to heat an empty water heater</p> <ul style="list-style-type: none"> • Make sure that water is poured into the cup before turning on the heater unit in order to prevent the heater unit from heating the cup without water. Heating of an empty water heater may result in burning of the heater. • Exercise caution as heating of an empty water heater may result in burning of the heater, leading to fire.
 	<p>17. Troubleshooting and contact information</p> <p>In the case of any problems, discontinue use, turn off the main switch and contact the dealer or our company.</p>
	<p>18. Use the turbine with a water check valve</p> <p>Use the turbine with a water check valve. Contact the dealer or our company when a turbine without a water check valve will be used.</p>
	<p>19. Cautions when adjusting the height of the doctor table</p> <ul style="list-style-type: none"> • Turn off the main switch before adjusting table height. • Be sure to slide down the collar on the lock ring after removing the lock ring. • Please confirm whether a table is fixed. If the table is not fixed surely, it causes a fall and the accident during operation.
	<p>20. Do not place an undue load to the spittoon bowl</p> <p>Make sure that the patient does not lean to the spittoon bowl as pushing on the spittoon bowl causes it to swing outwards.</p>
	<p>21. Prohibition of maintenance</p> <p>During operation, repair and maintenance are prohibited.</p>
	<p>22. Prohibition of using this equipment adjacent to or stacked with other electronic equipment</p> <p>Use of this equipment adjacent to or stacked with other equipment should be avoided because it could result in improper operation. If such use is necessary, this equipment and the other equipment should be observed to verify that they are operating normally.</p>
	<p>23. Prohibition of placing portable RF communications equipment adjacent to this product</p> <p>Portable RF communications equipment (including peripherals such as antenna cables and external antennas) should be used no closer than 30 cm (12 inches) to any part of the tbCOMPASS, including cables specified by the manufacturer. Otherwise, degradation of the performance of this equipment could result.</p>









SAFETY PRECAUTIONS (Please observe safety precautions fully)

⚠ CAUTION

	<p>1. Only experienced personnel should use this product</p> <p>Only dentists or other dental professionals should use this product.</p>
	<p>2. Confirm safety before use</p> <p>Before use, confirm that the parts are correctly and safely operating and that there are no obstacles around this product.</p>
	<p>3. Pay attention to patients and children</p> <p>Keep your eyes on patients (especially, children) so that mischief or inadvertent operation of equipment will not lead to unexpected accidents.</p>
	<p>4. Discontinue use if you feel that “something is wrong”</p> <p>Always be careful to inspect this product for looseness, rattling, tilting, wobbling, sounds, temperature, odors, etc. Immediately discontinue use at the first feeling that “something is wrong.”</p>
	<p>5. Do not smack or rub this product</p> <p>Do not smack or rub this product forcefully. This could cause damage to covers or defective function.</p>
 	<p>6. Precautions when using water other than tap water</p> <p>The water unit is intended for use with tap water. Caution should be exercised as the use of water other than tap water (water through a sterilizer or water systems, etc.) may result in failure of equipment.</p>
	<p>7. Practice of flush out</p> <p>Practice the flush out of water retained in the unit before the start of clinical practice at the beginning of each work day to maintain the quality of water for dental treatment and ensure a steady supply of water to handpieces. Refer to the procedure for flush out.</p>
	<p>8. Do not place anything hot on the Doctor's table</p> <p>Do not place anything hot on the Doctor's table. This could cause deformation or discoloration.</p>
	<p>9. Put a cover on the scaler tip</p> <p>After use, be sure to put the dedicated tip cover (if a cover comes with the unit) on the scaler in the holder. If the cover is not used, injury from the scaler tip may occur.</p>
	<p>10. Close the water main valve and turn off the main switch upon completion of work</p> <p>Be sure to close the water main valve and the main switch at the end of each work day to prevent water leakage from occurring.</p>
	<p>11. Keep your eyes on the patient during operation.</p> <ul style="list-style-type: none"> • Confirm that the patient is seated in the proper position. Keep your eyes on the patient during the operation. • Pay special attention to surroundings at automatic operation of the dental treatment table. Damage to the backrest, stool or Doctor's table may occur.
	<p>12. Precautions when using handpieces, etc.</p> <p>In order to ensure safety, be sure to confirm that rotation has completely stopped before changing the rotation speed of the micromotor or inserting/removing the bar of handpieces. See the Instruction Manual accompanying various handpieces and appendix of the optional handpiece operating manuals included in the product for further information.</p>
	<p>13. Observe the hose</p> <p>Do not step on the hose (foot controller hose, vacuum hose, saliva ejector hose). Failure to heed this warning may result in damage to the hose, as well as people tripping over.</p>











SAFETY PRECAUTIONS (Please observe safety precautions fully)

⚠ CAUTION

	<p>14. Use dental paper cups (Optional sensor cupfiller)</p> <p>Use dental paper cups for sensor cupfiller (optional). If the cup is another material grade (such as stainless steel and plastics) or if the paper cup is of dark color or pattern, which the sensing cup filling sensor may not respond.</p>
	<p>15. Do not use water other than purified water, distilled water or pure water for the water tank</p> <ul style="list-style-type: none"> • The water tank is intended only for use with purified water, distilled water and pure water. • Do not use mouthwash or electrolyzed water, such as ConCool or povidone iodine, as they may cause clogged tubing or affect internal valves and equipment.
	<p>16. Set the pressure of the water tank at 29psi or less</p> <p>Adjust the air supply pressure for the water tank to 29psi or less. An excessively high pressure may cause damage to the water tank.</p>
	<p>17. Read the documents accompanying the various pieces of equipment</p> <p>Before use, be sure to carefully read the package inserts and Instruction Manuals accompanying the various pieces of equipment (including optional articles) to ensure proper use.</p>
	<p>18. Precautions for handling synthetic leather</p> <ul style="list-style-type: none"> ● Stain caused by clothing dyes The synthetic leather of this product may become stained by direct contact with clothes or belts. If there is stains, wipe clean as quickly as possible with a 10% detergent solution diluted using water to prevent permanent staining. ● Take care of deformation or stains due to direct contact <ul style="list-style-type: none"> • Direct contact with other objects such as plastic products, painted items, solvents or adhesive tape may cause changes to the surface luster, cracking, deformation or peeling. • Direct contact with newspaper or printed paper may cause stains. • Direct contact with items of clothing such as printed images of T-shirts, or jeans may cause discoloration of the synthetic leather of this product. • Direct contact with solvents such as benzene nail polish remover, alcohol may cause discoloration, melting of the surface, elution of the plasticizing agent, changes to surface luster, hardening/softening or peeling. • Using bleach or bleached sheets may cause changes to surface luster or discoloration. • Installing this product next to sources of excess heat such as irons or heaters may cause deformation or discoloration. • Protect this product from direct sunlight by installing curtains. Failure to follow this instruction may cause changes, shrinking, discoloration or fading of the leather surface. • Placing heavy objects for a long period of time may leave an imprint of wrinkles on the synthetic leather that cannot be removed.
	<p>19. Be sure to operate switches with your hands</p> <p>Be sure to operate switches with your hands, except the foot controller, which is operated with your foot. Operation with body parts other than hands may cause damage or incorrect operation.</p>
	<p>20. Pay attention during movement of the Doctor's table</p> <ul style="list-style-type: none"> • Pay attention to surroundings when you move the Doctor's table. Injury by the tips of handpieces, etc., may occur. • Be sure to move the Doctor's table by holding the handle of the unit.
	<p>21. Wash the filter in the solid collector with running water</p> <p>Detach and wash the filter in the solid collector with running water. The filter may break if wash it with brushes.</p>









SAFETY PRECAUTIONS (Please observe safety precautions fully)

⚠ CAUTION

	<p>22. Pay attention to contact injury during automatic operation of the dental unit</p> <p>Pay special attention to surroundings during automatic operation of the dental treatment table. Damage to the backrest, stool or Doctor's table may occur. Confirm that the patient is seated in the proper position and keep your eyes on the patient during operation.</p>
	<p>23. Immediately wipe off drug solution when it comes into contact with this unit</p> <p>Should drug solution or water comes into contact with this unit, immediately wipe it off with a dry soft towel, etc. This could result in defective function or electric leakage as well as spotting or rusting.</p>
	<p>24. Precautions after the cleaning of 77-type 3-way syringe</p> <p>Tighten the nut securely as loosening of the nut of the syringe nozzle may result in detachment of the nut and nozzle during use.</p>
	<p>25. Precautions for cleaning the doctor control panel</p> <p>Penetration of droplets of sanitizing spray into the back of the doctor control panel may be associated with switch failure. Use a paper towel soaked with sanitizing solution to clean the surface of the operation panel.</p>
	<p>26. Precautions for cleaning of the spittoon bowl</p> <ul style="list-style-type: none"> • The spittoon bowl is made of glass or ceramic (optional). It may break if it is impacted. Do not wash it with hot water. Otherwise, it may break. • Never use sandpaper, metal scrub brushes or abrasive cleaning agents to clean the bowl. • Do not use strongly acidic cleaning agents or alkaline pipe cleaning agents, which may cause corrosion of metals, etc.
	<p>27. Pay attention to water discharge when attach/detach the spittoon bowl</p> <p>Make sure to turn the main switch off when you attach/detach the spittoon bowl. Cup filler sensor may react to hands. Resulting water spill.</p>
 	<p>28. Precautions for cleaning the resin cover</p> <p>For cleaning, do not use cleaning agents containing solvent or abrasives, thinners or oil-based alcohol (butanol and isopropyl alcohol), which may cause cracks.</p>
	<p>29. Precautions for sterilization</p> <p>Do not sterilize besides the procedures that we provide. This could cause damage to the unit.</p>
	<p>30. Precautions when cleaning the sensor cup filler (Optional)</p> <p>Do not clean the sensor cup filler with water. Malfunction may occur as the sensor is not waterproof. Also refer to the precautions when cleaning the resin cover described in item 28 above.</p>

SAFETY PRECAUTIONS (Please observe safety precautions fully)

⚠ CAUTION

	<p>31. Precautions for right/left handed conversion</p> <ul style="list-style-type: none"> • Make sure read through pages 36~41 for instructions before perform with right and left handed conversion. This could cause physical injury or property damage. • Take care not to contact the doctor table to the cuspidor during conversion. • Take care not to pinch the vacuum hose and saliva ejector hose between the assistant arm and the cuspidor swing arm during this conversion.
	<p>32. Pay attention during the headrest operation</p> <ul style="list-style-type: none"> • The headrest will be come off from the backrest in case of pulling too much. • Do not allow hands, fingers or hair to become entangled in the moving parts of the headrest.
	<p>33. Do not adjust the holder support arm and instrument holder</p> <p>Do not adjust the holder support arm and instrument holder. Because the angle adjustment of the holder is fixed at the point of installation, the holder support arm will be damaged in case it is moved too hard.</p>
	<p>34. Precautions for adjusting the assistant holder arm (Optional)</p> <p>Be careful not to pinch your finger when adjusting the assistant holder height.</p>
	<p>35. Precautions for cleaning the assistant control panel</p> <p>Penetration of droplets of sanitizing spray into the back of the assistant control panel may be associated with switch failure. Use a paper towel soaked with sanitizing solution to clean the surface of the assistant control panel.</p>
	<p>36. Precautions for cleaning the vacuum / saliva ejector lines</p> <p>Do not use strongly acidic cleaning agents or alkaline pipe cleaning agents, which may cause corrosion of metals, etc/</p>
	<p>37. Precautions for cleaning the vacuum / saliva ejector handpiece and syringe</p> <p>Cleaning must be done within 1 hour after use. Replace with a new vacuum handpiece and saliva ejector handpiece for following cases.</p> <ul style="list-style-type: none"> • Any waste material can not be removed by clogged hole. • Contamination and solid material attached to vacuum handpiece and saliva ejector can not be removed.
	<p>38. Precautions for sterilization of vacuum / saliva ejector handpiece and syringe</p> <ul style="list-style-type: none"> • Sterilization by class B cycles. • Sterilization temperature is 135 degrees or less. • The cap, filter and body are made of resin. They may become deteriorated if they are sterilized in an autoclave many times. • After autoclave sterilization, the cap, filter, body and valve are subject to discoloration, which does not have a negative effect on performance. • The slide knob can be autoclave 100 times and is expendable supplies. • Dry naturally if the temperature for drying process is to exceed 135 degrees. • If damage occurs to the sterilization pouch, discard and sterilize again using a new pouch.
	<p>39. Precaution for cleaning of vacuum / saliva ejector handpiece and syringe</p> <ul style="list-style-type: none"> • Clean the filter carefully with running water. Do not use brush to clean the filter, it may cause damage to the filter. • After daily operation, run two cup of clean water through handpieces to clean inside.

SAFETY PRECAUTIONS (Please observe safety precautions fully)

NOTICE

1. Check operation of the compressor

With no air supplied, this product does not operate even after turning on the main switch. Turn on the power of the compressor before operating this product.

2. Handling of equipment in the case of a power failure

Put the handpiece in the holder and turn off the main switch if equipment stops working during use due to a power failure or other reasons.

3. Handling of the single articulating headrest (Optional)

Push the headrest forward while lift up the headrest lever, the headrest moves smoother.

4. Handling of the foot controller

When foot controller pedal is stepped on, the safety function for stopping chair operation is activated.

5. Handling of the water heater

Water drips from the cupfiller nozzle when the water in the water heater is heated. This phenomenon is not a sign of failure.

6. Use of flow rate adjustment knobs

Flow rate adjustment knobs for water and air are intended to increase/decrease the flow rate, but do not serve as stop valves. Caution should be exercised as tuning the knob excessively may cause it to turn free.

SAFETY PRECAUTIONS (Please observe safety precautions fully)

■ Caution Points During Operation of the Product

Description of Symbol Marks

- ➔ Caution areas such as moving parts, rotating parts and detachable parts to which caution should be paid.
- Caution areas that are provided with an emergency stop mechanism.

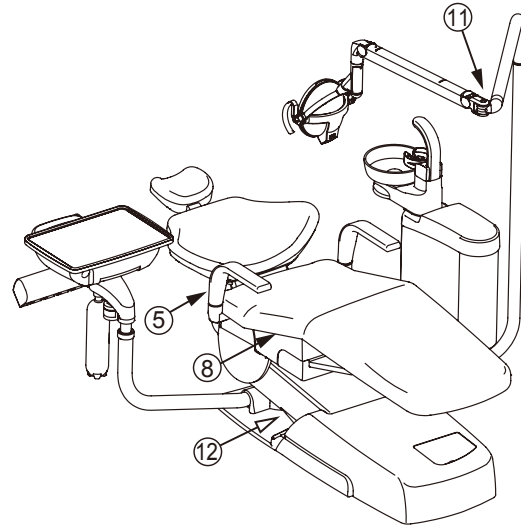
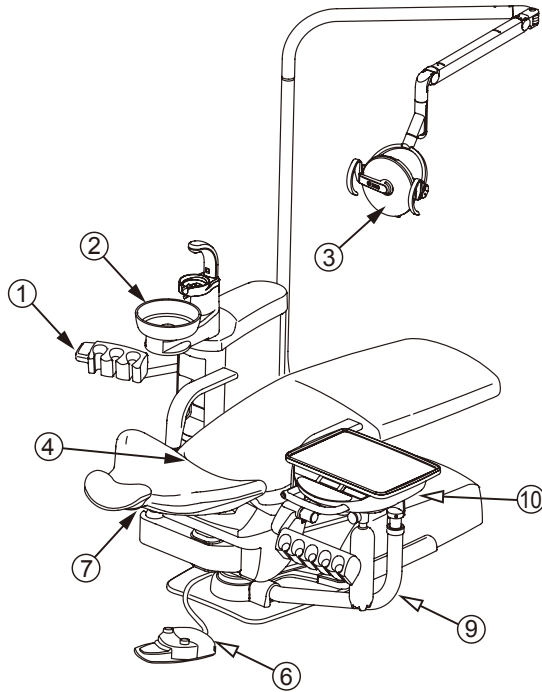

① Be aware of contact with the assistant's instrument holder.

Ensure that the upper body of the patient does not go beyond the armrest into the cuspidor unit.

② The cuspidor unit's rotation

Make sure that the patient does not lean on the cuspidor unit, as pushing on the spittoon bowl causes it to swing outwards.

③ Ensure that the reflector cover is securely in place.

The mirror cover must be installed securely. (701)

④ Take care not to be trapped by moving parts of the backrest.

Do not put hands or feet into the gap between the backrest and the seat.

⑤ Take care not to be trapped by the armrest.

Do not operate the chair with the right armrest swing out 90 degrees.

⑥ Foot controller safety function

The chair movement stops when press the foot controller during chair auto movement.

⑦ Take care not to be trapped by moving parts of the headrest.

Do not allow hands, fingers, or hair to become entangled in the moving parts of the headrest.

⑧ Take care not to be trapped by the lower part of the seat.

Do not put hands or feet into the gap in the lower part of the seat.

⑨ Check the locking mechanism of the primary arm.

Check that, when moving the instrument table to the back of the backrest, the chair lock indicator on the doctor control panel blinks red, and operation of the chair is halted.

⑩ Be aware of interference between the chair and the table.

Do not move the table under the moving parts of the chair.

⑪ Pay attention during patient sitting down or getting up.

Take care of patient should not hit to the dental light swing arm when sitting down or getting up from the chair.

⑫ Take care not to be trapped between the sub link cover and the base plate

Do not allow feet or obstruct between the sub link cover and the base plate.

PRACTICE OF FLUSH OUT

Precautions for water quality

CAUTION

Practice the flush out of water retained in the unit at the beginning of each work day to maintain the quality of dental treatment water and ensure a steady supply of water to handpieces.

- After this unit has not been used for a long period of time (at the beginning of the week, in the morning, etc.), water retained in the hose inside the unit or water heater will create an environment where unwanted bacteria are likely to grow. In order to ensure safe treatment and untroubled operation of handpieces, practice the flush out of the unit water line at the beginning of each work day.
- It is recommended that flush out of water inside the unit and hose of handpieces should be performed with fresh water at the end of morning office hours and at the end of each work day to inhibit the growth of unwanted bacteria.

Procedure of flush out

■ Standard Package

<ul style="list-style-type: none"> ● Handpiece line Handpiece Syringe (Doctor Table, Cuspidor) 	<ul style="list-style-type: none"> • Flushout procedures for handpiece line, please refer to Page 44 selection 3 for operation of flushout Mode I or Mode II. • Flushout of the syringe, flushing out the syringe water approximately 40 seconds.
<ul style="list-style-type: none"> ● Cuspidor line Cupfiller (water heater) Bowl flush 	<ul style="list-style-type: none"> • Flushout procedures for cuspidor line, please refer to Page 44 selection 3 for operation of flushout Mode II.

■ Cuspidor Package

<ul style="list-style-type: none"> ● Handpiece line Syringe (Cuspidor) 	<ul style="list-style-type: none"> • Flushout of the syringe, flushing out the syringe water approximately 40 seconds.
<ul style="list-style-type: none"> ● Cuspidor line Cupfiller (water heater) Bowl flush 	<ul style="list-style-type: none"> • For flushing out of cupfiller line, place the cup on the cupfiller base. The water filled to the cup and drain the water of the cup to flushing out the cupfiller water. Repeat it 7~8 times. • For continuous bowl flushing, please refer to page 22 for section of cuspidor bowl flush switch.

■ Doctor Package / Vacuum Package

<ul style="list-style-type: none"> ● Handpiece line Handpiece Syringe (Doctor Table/Vacuum Package) 	<ul style="list-style-type: none"> • Flushout procedures for handpiece line, please refer to Page 44 selection 3 for operation of flushout Mode I. • Flushout of the syringe, flushing out the syringe water approximately 40 seconds.
---	--

OVERVIEW AND MAJOR COMPONENTS

■ Overview and Major Components (Standard Package)

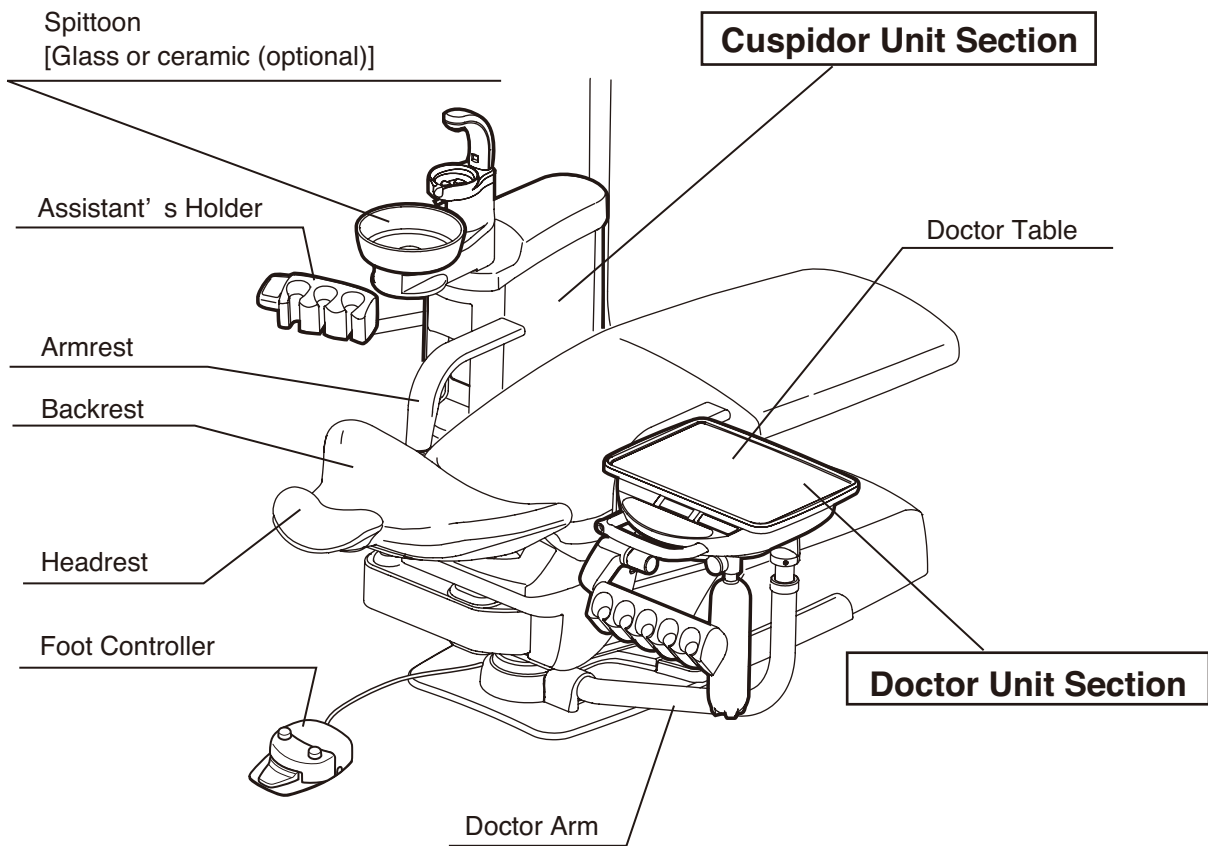

■ Overview and Major Components (Vacuum Package)

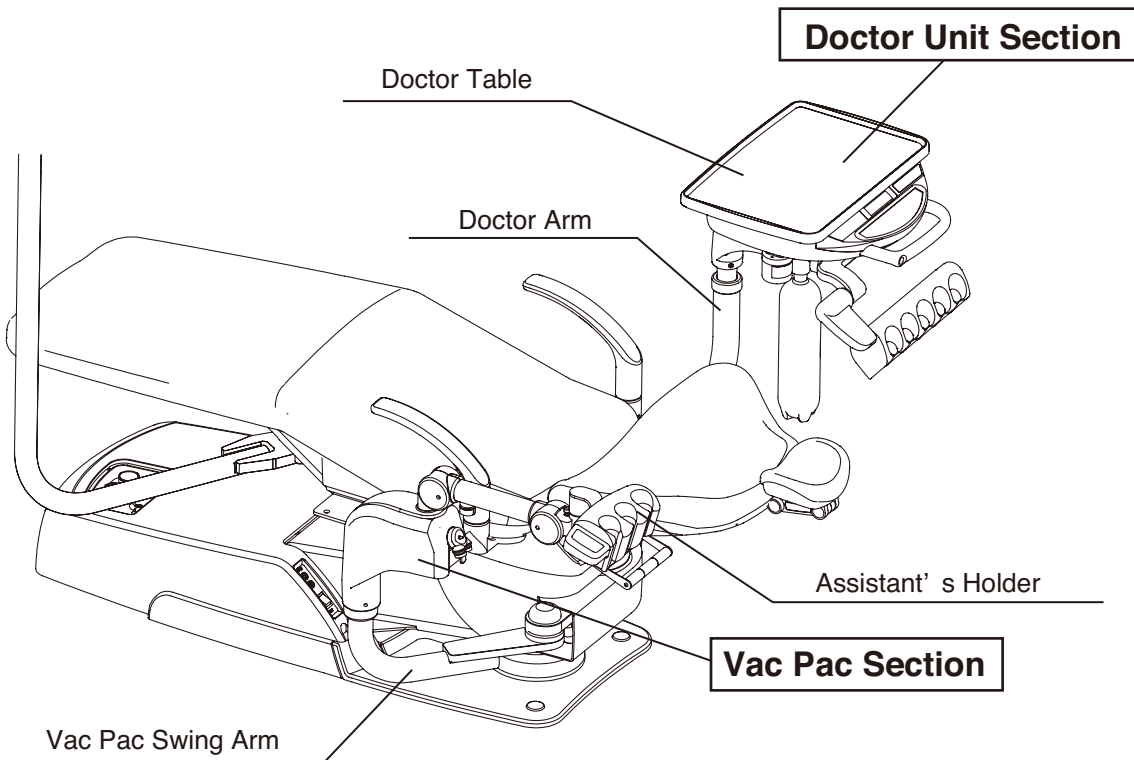

OVERVIEW AND MAJOR COMPONENTS

■ Doctor Unit Section

• Holder Type

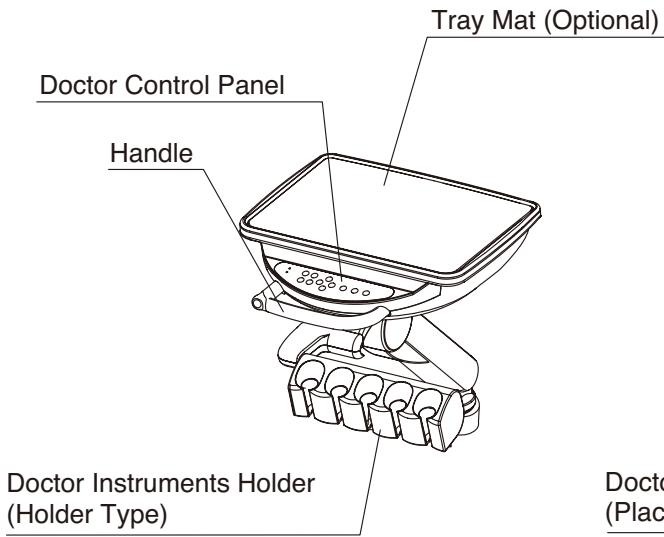

• Place Holder Type

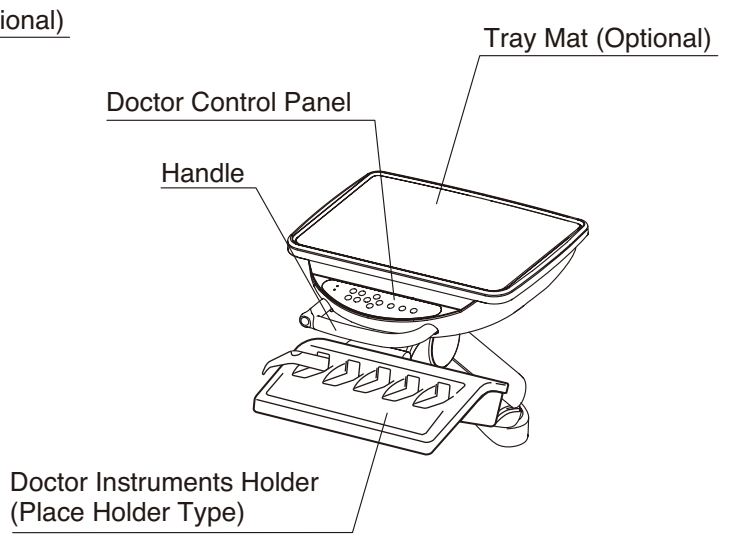

■ Cuspidor Unit Section

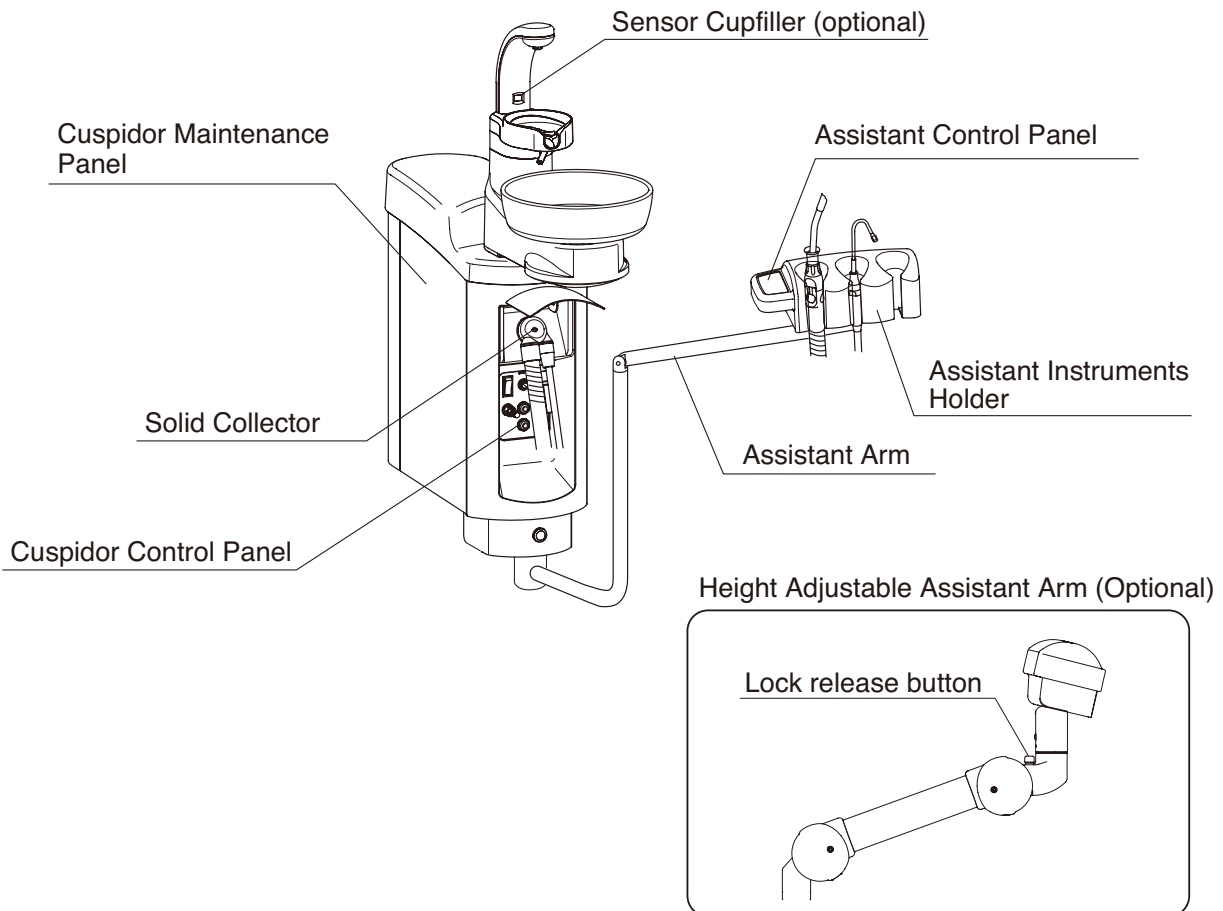

OVERVIEW AND MAJOR COMPONENTS

■ Vac Pac Section (Vacuum Package)

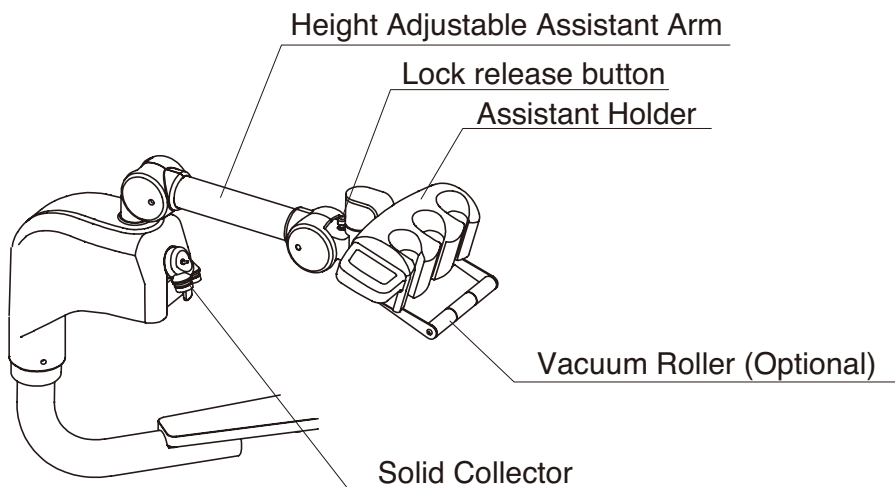

■ Junction Box Section

- ◆ Water main valve (inside junction box)
Turn clockwise to open and counter-clockwise to close.
- ◆ Drain valve
Drains the water collected at the air filter on the main water supply line.
- ◆ Fuse holder
 - The main fuse of units is built-in.
 - Turn off the main switch when replacing the fuse.
 - The capacity of the fuse displays it on the left side of the fuse holder.

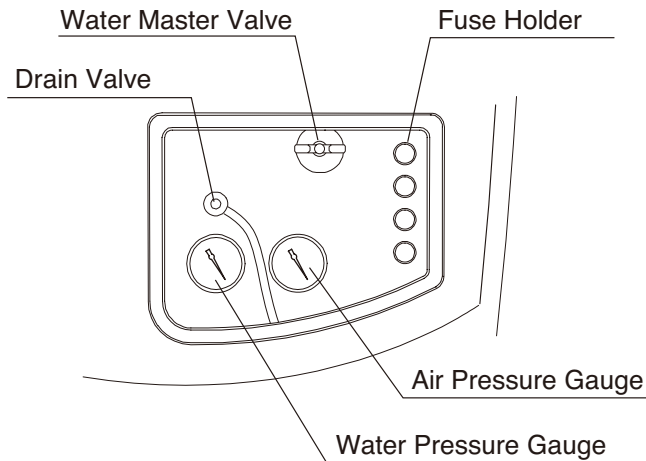

1 Chair Section

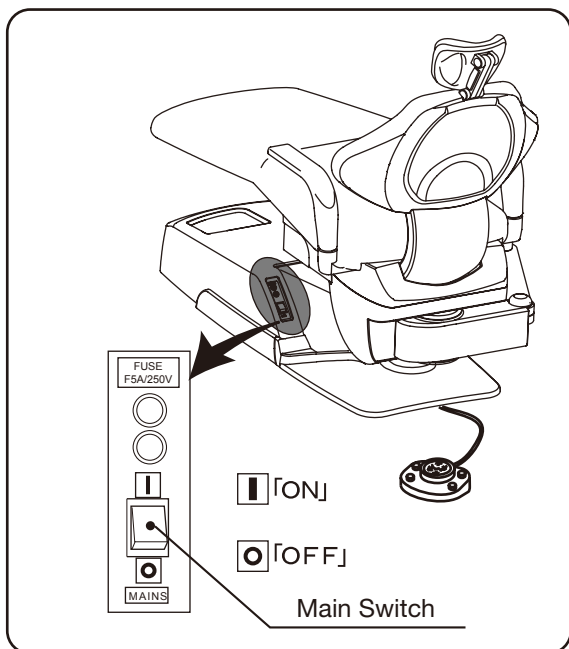

■ Main Switch (Chair Section)

Turn on the main switch located on the left side of the pump cover. A green lamp in the main switch will illuminate.

⚠ CAUTION

- Operate the main switch by hand only.
- Turn off the main switch after daily operation.

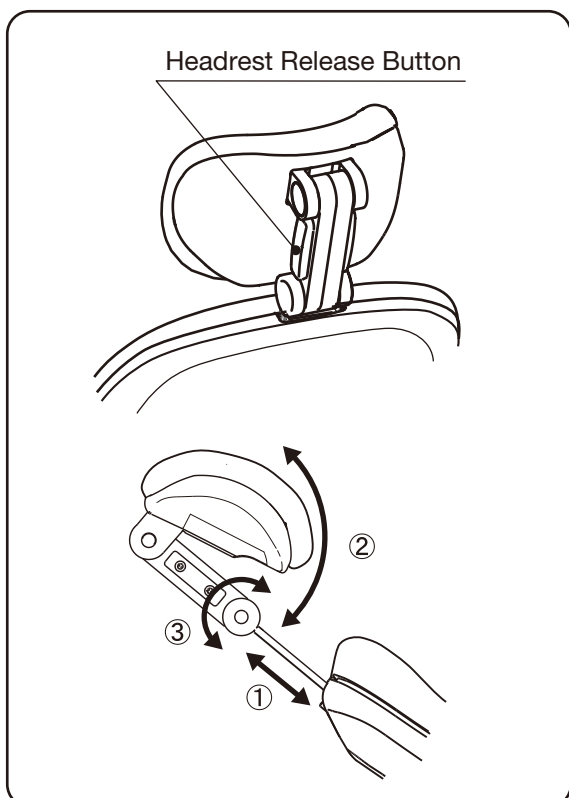

■ Twin Articulating Headrest Headrest

① Height Adjustment

Hold the headrest bar with both hands and adjust headrest height by pulling out or pressing down on the headrest bar.

② & ③ Angle Adjustment

Hold the headrest release button to unlock the twin axis mechanism and adjust headrest angle. The headrest angle is locked when the headrest release button is released.

* Does not move the right side release button of headrest, it is fixed.

⚠ CAUTION

- The headrest will be come off from the backrest in case of pulling too much.
- Do not allow hands, fingers or hair to become entangled in the moving parts of the headrest.

DESCRIPTION OF OPERATION AND FUNCTIONS OF COMPONENTS

1 Chair Section

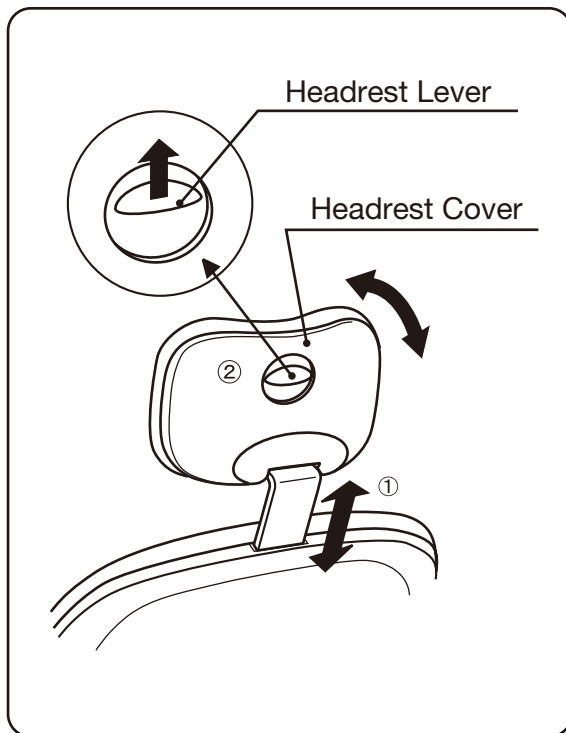

■ Single Articulating Headrest (Optional)

① Height Adjustment

Hold the headrest bar with both hands and adjust headrest height by pulling out or pressing down on the headrest bar.

② Angle Adjustment

Push the headrest to forward as required.

Lift up the headrest lever to unlock position and adjust headrest angle to backward. Headrest angle is locked when the headrest lever is released.

NOTICE

Push the headrest forward while lift the headrest lever, headrest moves smoother.

⚠ CAUTION

- The headrest will be come off from the backrest in case of pulling too much.
- Do not allow hands, fingers or hair to become entangled in the moving parts of the headrest.

■ Foot Switch (Optional)

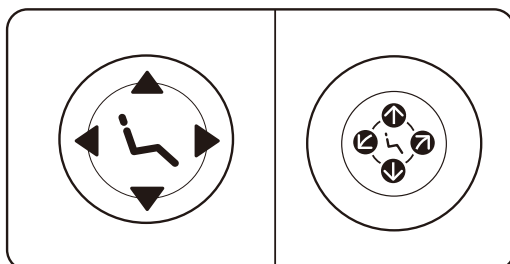
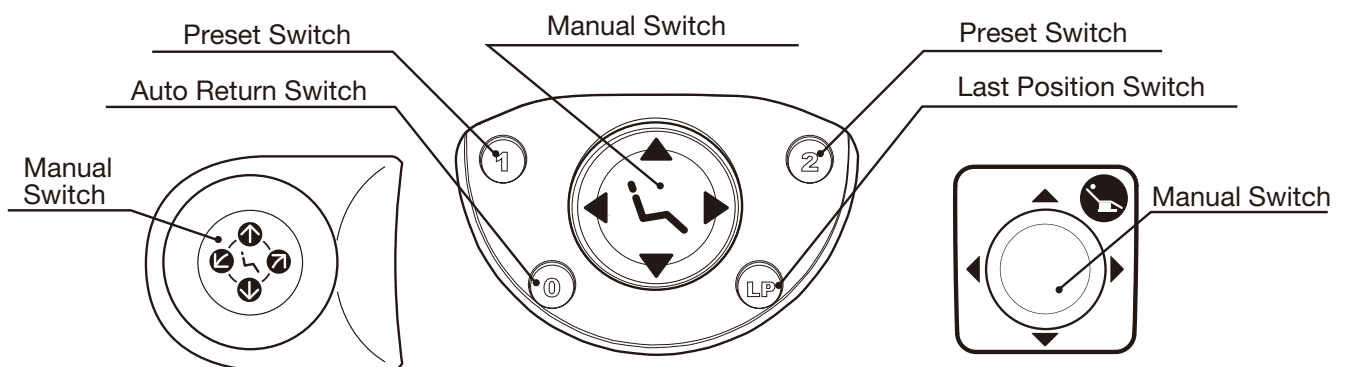

◆ Manual Switch

- Operating instruction for chair manual operation

- Pressing ▲ ⬆ will move the chair up
- Pressing ▼ ⬇ will move the chair down
- Pressing ◀ ⌛ will move the backrest reclining
- Pressing ▶ ⌛ will move the backrest raising

* The chair is moving while pressing a switch.

1 Chair Section

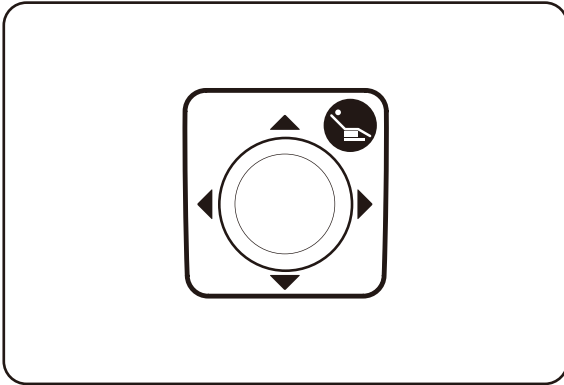

◆ Manual Switch

- Operating instruction for chair manual operation

Pressing ▲ will move the chair up
 Pressing ▼ will move the chair down
 Pressing ◀ will move the backrest reclining
 Pressing ▶ will move the backrest raising
 * The chair is moving while pressing a switch.

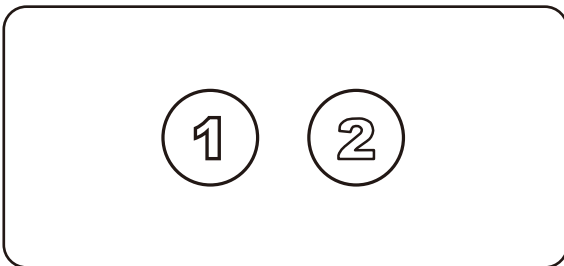

◆ Preset Switch

- Momentarily press the ① switch, the chair will move to desired preset 1 position automatically.
- Momentarily press the ② switch, the chair will move to desired preset 2 position automatically.

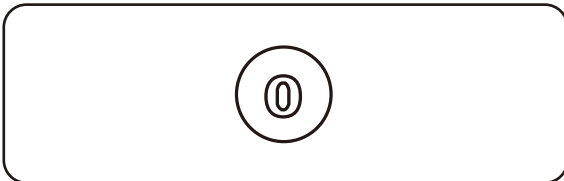

◆ Auto Return Switch

- Momentarily press the ① switch will lower the chair and raise the backrest to the initial position.

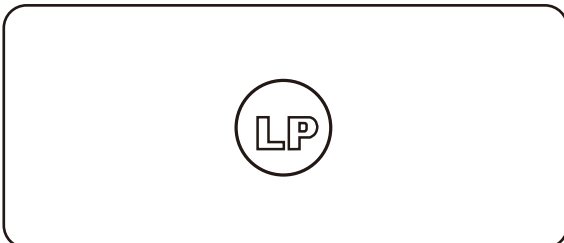

◆ Last Position Switch

- Momentarily press the ① switch with the chair in the treatment position moves the chair to the rinsing position and another press of this switch returns the chair to the original fine-tuned treatment position.

*Immediately release any auto mode switches after depressing them, because when any auto mode switches are depressed about five seconds, the chair position will be set up to preset with buzzer sound.

Refer to page_42 “Preset position setup procedures” for the setting of each position.

⚠ CAUTION

Be careful that the stool will not be caught in the gap between the chair and the headrest when the chair is operated with an auto-switch. Damage to the backrest, stool or Doctor's table may occur. Confirm that the patient is seated in the proper position before operation of the chair and keep your eyes on the patient during operation.

DESCRIPTION OF OPERATION AND FUNCTIONS OF COMPONENTS

2 Doctor Unit Section

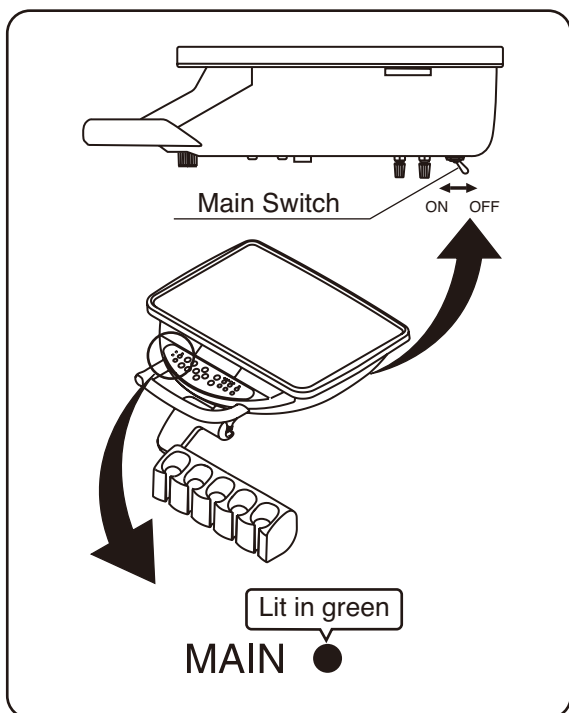

■ Main Switch (Unit Section)

• When the main switch is turned on, the MAIN LED on the doctor control panel lights up in green. This state permits motion of the unit, chair and dental light.. The unit can be moved even while the chair is OFF.

• When the main switch is turned on, all the lamps on the doctor control panel light up, and the following is displayed on the indicator.

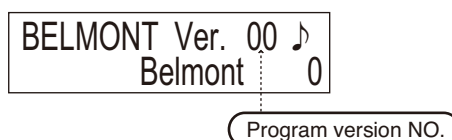

• A few seconds later,



" BELMONT " is displayed and all the functions can be operated.

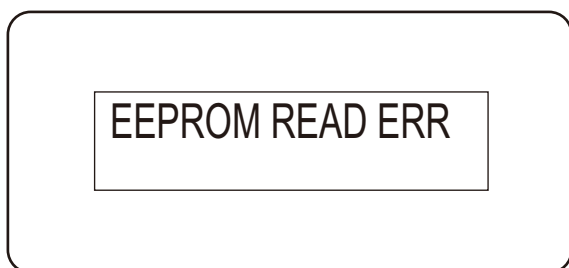

If any error arises to the memory, the buzzer sounds and [EEPROM READ ERR] is displayed on the indicator.

Once turn off the main switch and then turn on the main switch again. If an error message is still displayed, please contact your dealer or our office.

* This doctor unit section is actuated by compressed air. Therefore, ensure that the air compressor is working.

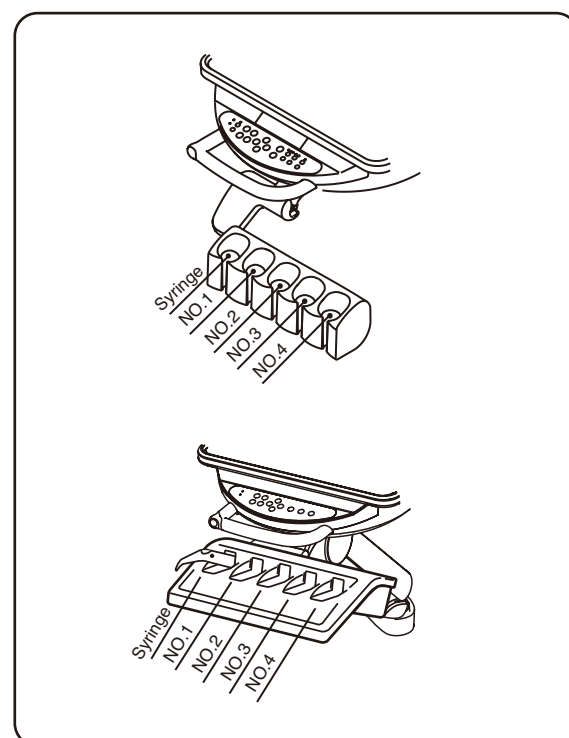

When the main switch is turned on, whether handpieces are accurately fitted in instrument holders or not is checked automatically. If any handpiece is not accurately fitted in its instrument holder at this occasion, the subject holder number (counted as No. 1, 2 and so forth from facing left excluding syringe) is displayed on the indicator and the buzzer sounds for a few seconds. Accurately fit the handpiece in the displayed holder.

If the handpiece is accurately fitted while the buzzer sounds (for a few seconds), the buzzer stops, and the section become operative.

If the buzzer stops in the mid-way of the work, turn off the main switch, accurately fit the handpiece and turn on the main switch again about 5 seconds later. Then, use of the section is permitted.

2 Doctor Unit Section

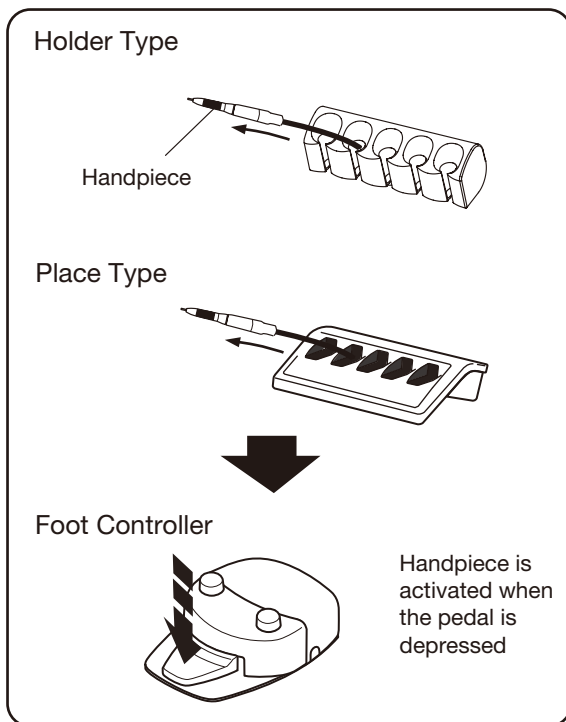

■ Handpiece

- The handpiece is actuated by picking it up from the instrument holder and operating the foot controller.

See pages 26 for operation of foot controller, micromotor and electric scaler.

NOTICE

Operation of the each handpieces, please refer to the appendix for optional handpiece operating instructions.

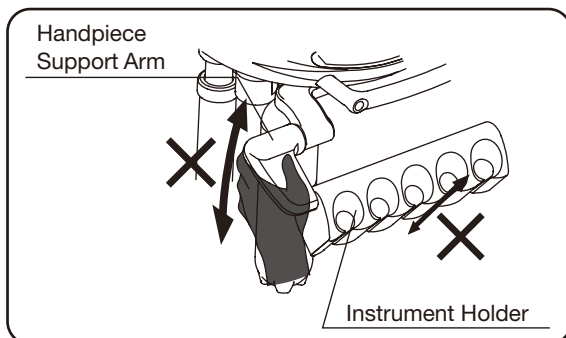

⚠ CAUTION

Do not adjust the holder support arm and instrument holder. Because the angle adjustment of the holder is fixed at the point of installation, the holder support arm will be damaged in case it is moved too hard.

No.1

■ Handpiece priority function (first priority)

Only one handpiece, which was picked up first of all, is operable. The holder No. of the operable handpiece is displayed on the indicator.

ERR

If multiple handpieces are picked up in succession from the holder, and the handpiece that was picked up first is returned to the holder, error display [ERR] appears on the indicator. If error display appears, the normal state will be restored when all the handpieces are fitted in the holder.

Doctor Table

Handpiece Pressure Gauge

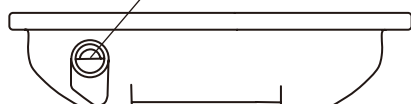

■ Handpiece air pressure gauge

Displays the handpiece drive air pressure.

DESCRIPTION OF OPERATION AND FUNCTIONS OF COMPONENTS

2 Doctor Unit Section

■ Description of doctor control panel

An overview of display on the doctor control panel and each switch on this doctor control panel is shown in the figure below. For detailed operating instruction, please see pages 19-26.

Each switch on the doctor control panel provides multiple functions, and various actions can be set when combined with the function switch. See pages 43-50.

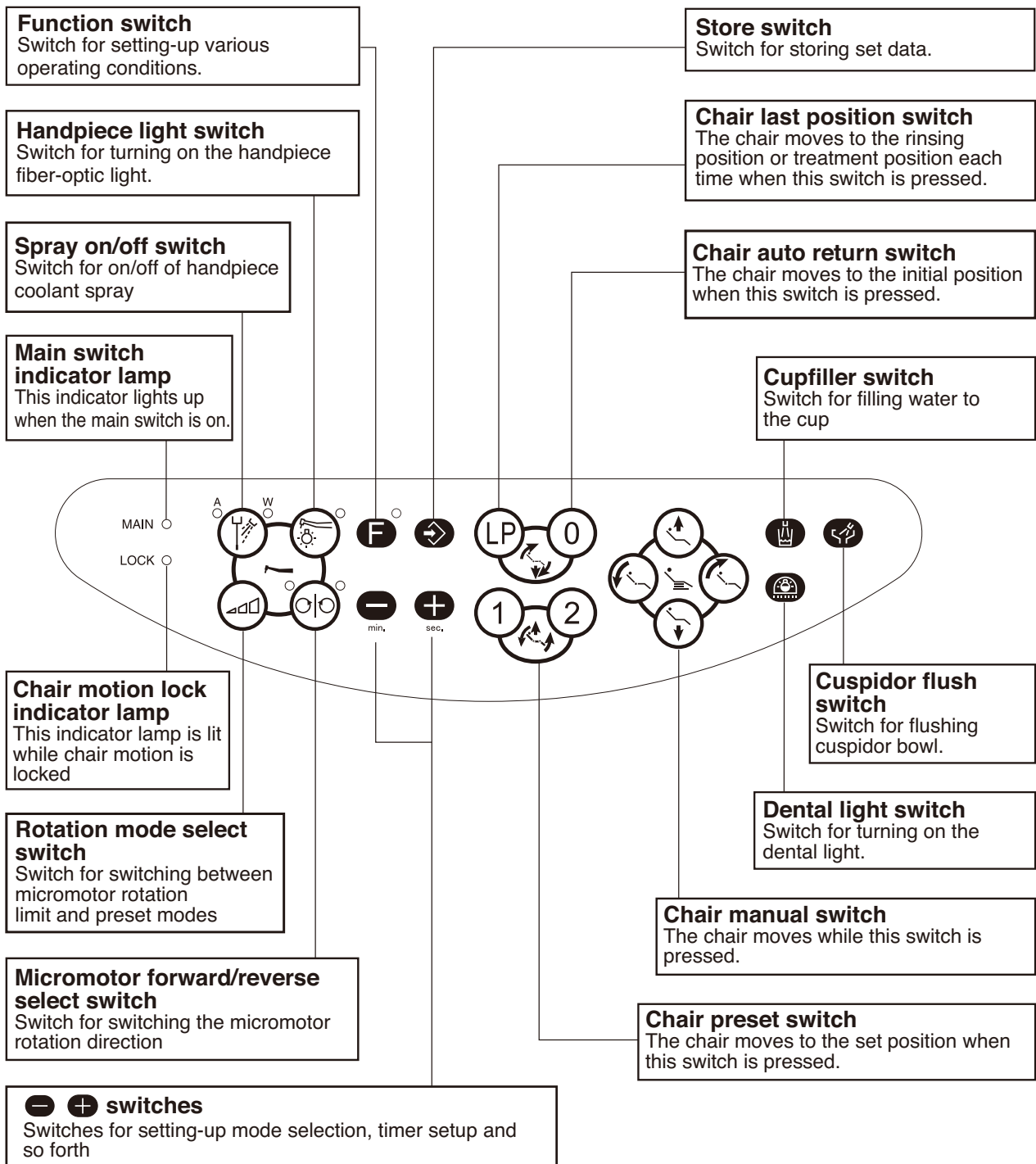

2 Doctor Unit Section

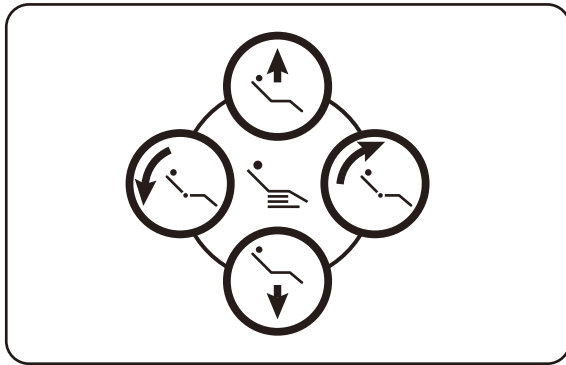

◆ Chair manual switch

Switches for manual up/down/backrest reclining of the chair.

- Press will move the chair up.
- Press will move the chair down
- Press will recline the backrest.
- Press will return the backrest.

*The chair is moving while pressing a switch.

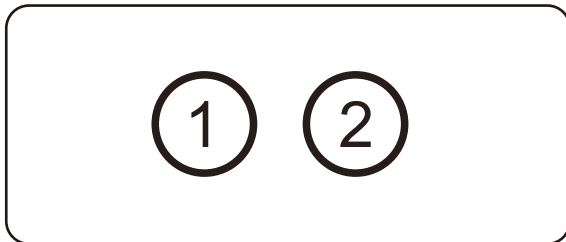

◆ Preset Switch

- Momentarily press the switch, the chair will move to desired preset 1 position automatically.
- Momentarily press the switch, the chair will move to desired preset 2 position automatically.

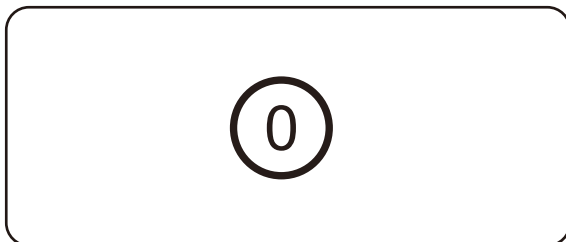

◆ Auto Return Switch

- Momentarily press the switch will lower the chair to the initial position and raise the backrest.



◆ Last Position Switch

- Momentarily press the switch with the chair in the treatment position moves the chair to the rinsing position and another press of this switch returns the chair to the original fine-tuned treatment position.

*Immediately release any auto mode switches after depressing them, because when any auto mode switches are depressed about five seconds, the chair position will be set up to preset with buzzer sound.

Refer to page_42 “Preset position setup procedures” for the setting of each position.

CAUTION

When operating the chair by the auto return switch, be careful not to nip the stool or the like by the chair backrest. Damage to the backrest, stool and/or doctor table could be caused. Furthermore, at the time of motion of the chair, ensure that the patient is sitting in a normal position and keep your eye on the patient while the chair is in motion.

DESCRIPTION OF OPERATION AND FUNCTIONS OF COMPONENTS

2 Doctor Unit Section

◆ Cancellation Function

During automatic movement (1,2,0,LP) by depress of following switches, the automatic movement will be cancelled and stopped immediately.

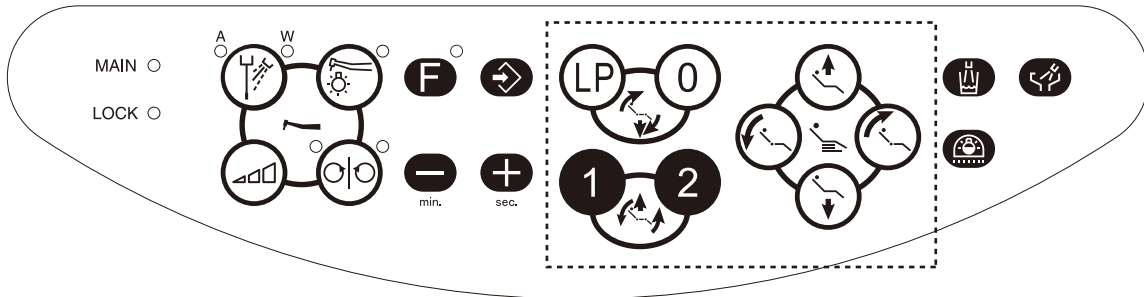

Doctor control panel

⋯ To stop the chair automatic movement, press any of switches surrounded by dotted lines.

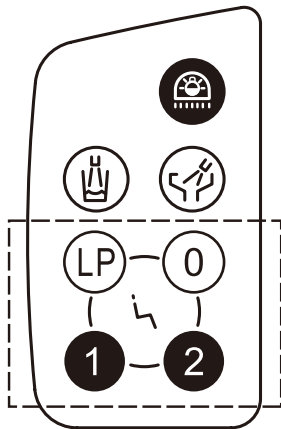

Assistant control panel

⋯ To stop the chair automatic movement, press any of switches surrounded by dotted lines.

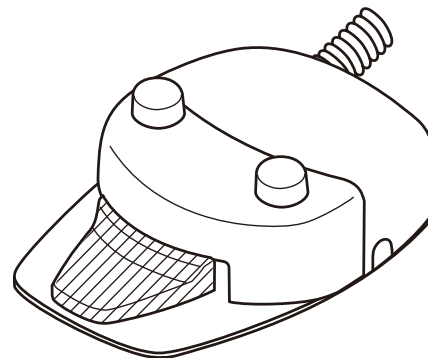

Foot controller

▨ To stop the chair automatic movement, by pressing shaded area.

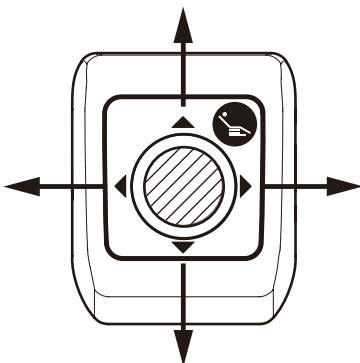

Foot switch (Optional)

▨ To stop the chair automatic movement, by pressing shaded area in the direction of an arrows.

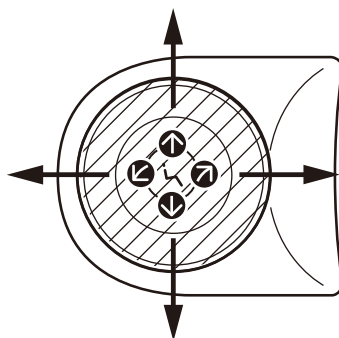

Foot switch (Optional)

▨ To stop the chair automatic movement, by pressing shaded area in the direction of an arrows.

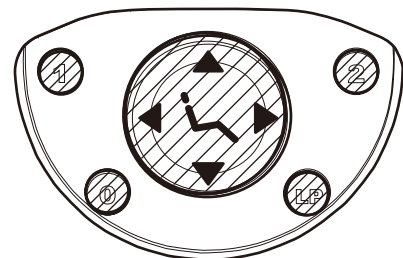

Foot switch (Optional)

▨ To stop the chair automatic movement, by pressing shaded area.

DESCRIPTION OF OPERATION AND FUNCTIONS OF COMPONENTS

2 Doctor Unit Section

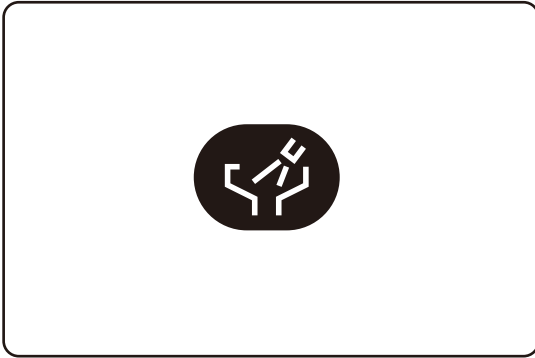

◆ Cuspidor bowl flush switch

- When this switch is pressed, water comes out of the bowl flush nozzle and flushes the cuspidor bowl.
- The timer is set for about 6 seconds.
- For continuous bowl flushing keep pressing this switch is for 2 seconds or longer.
- Press the cuspidor flush switch again for stopping flushing.

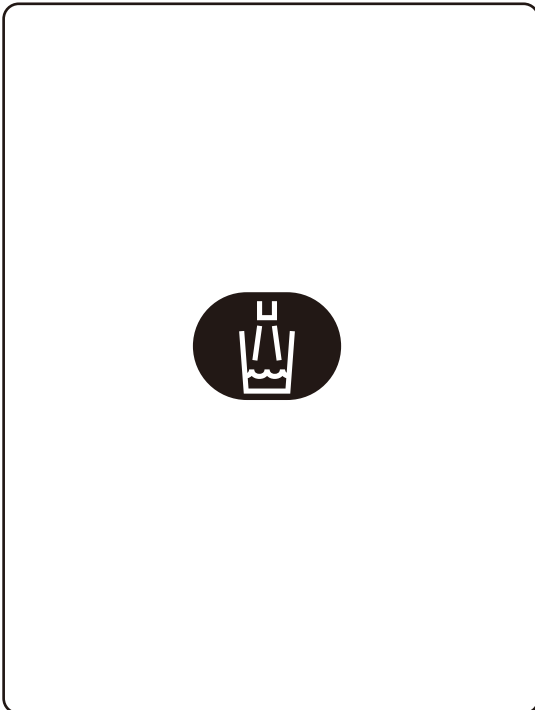

◆ Cupfiller switch

- Water is supplied through the cupfiller nozzle when this switch is pressed. Simultaneous with start-up of cupfiller motion, water comes out of the bowl flush nozzle and flushes the cuspidor bowl.
 - The quantity of water feeding is timed.
 - Press the cupfiller switch again for stop feeding.
- * When the cupfiller switch is pressed, water is supplied automatically for 3 to 4 seconds irrelevant to the water volume in the cup. Watch the overflow.
- * Do not press the switch while the cup is not in place.

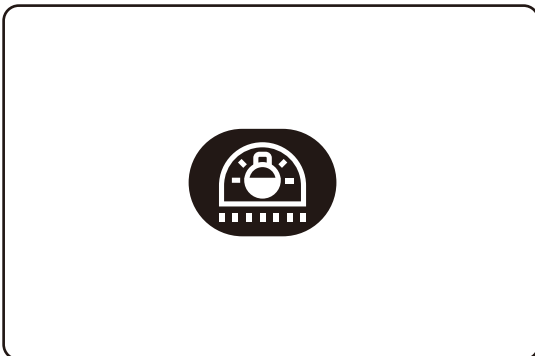

◆ Dental light on/off switch

- Switch for on/off the dental light.
-

2 Doctor Unit Section

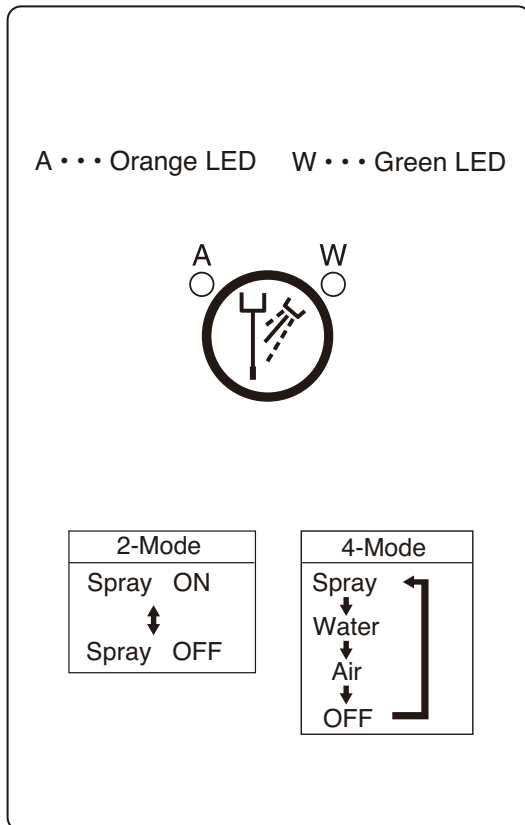

◆ Spray on/off switch

- Switch for on/off the handpiece coolant spray.
- When a handpiece is picked up and this switch is pressed, either LED A (air) or LED W (water) located on the left-hand side or right-hand side of the switch lights up, and indicates the selected function.
- In case of air motor or air turbine, switching between spray (both of LED A and LED W are lit) and OFF occurs when this switch is pressed.
- In case of electric scaler, switching between water only (LED W is lit) and OFF occurs when this switch is pressed, regardless of the mode.
- In case of micromotor, either the 2-mode or the 4-mode can be selected by mode select setup.
- When this switch is pressed in the 2-mode setup, switching between spray and OFF occurs.
- In case of 4-mode setup, switching occurs in the sequence indicated below each time when this switch is pressed:
Spray to Water only to Air only to OFF

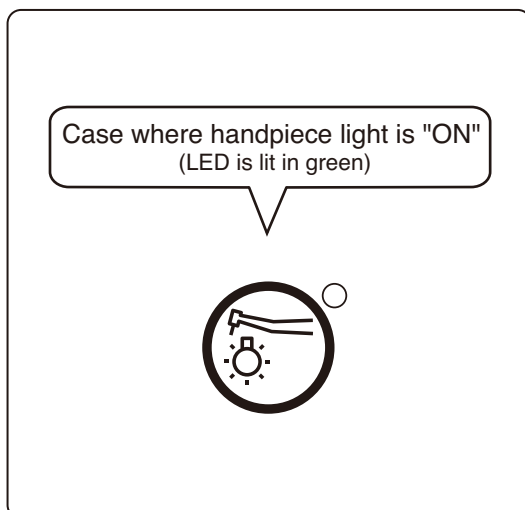

◆ Handpiece light on/off switch

- Switch for on/off the handpiece light.
- Switching between on and off of the handpiece light occurs each time when this switch is pressed.

2 Doctor Unit Section

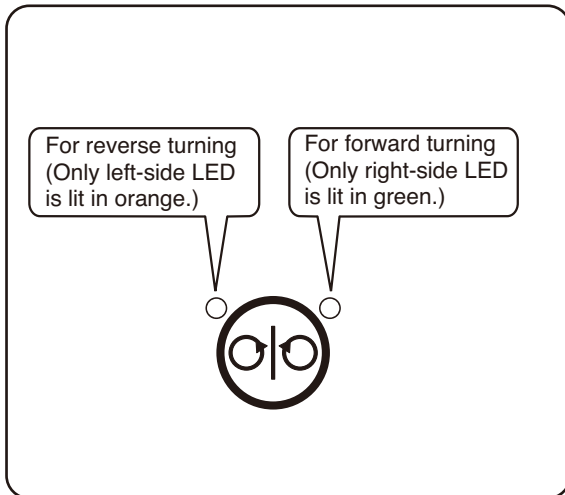

◆ Micromotor forward/reverse select switch

- Use this switch for switching the micromotor rotation direction. Pressing this switch each time changes the direction between forward (clockwise) rotation and reverse (counter-clockwise) rotation. Forward rotation is preset power is on.
- In case a micromotor set for reverse rotation is returned to its holder, the LED indicates forward rotation. When such a micromotor is picked up, however, the LED indicates reverse rotation and the alarm buzzer sounds.
- * The rotational direction cannot be switched during rotation of the micromotor. Use the switch after the micromotor stops.

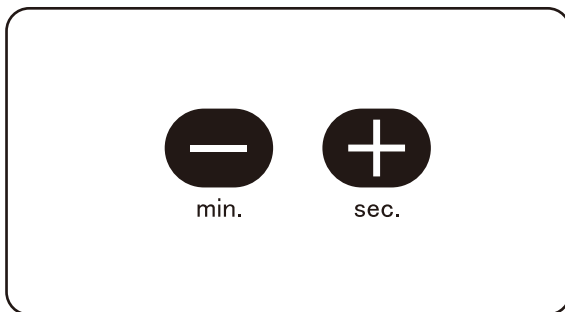

◆ (-) (+) switch

- These switches are used mainly for switching the handpiece setup mode.
- When the (-) switch or (+) switch is pressed, the upper limit of the micromotor rotation speed changes in 3 steps (or 5 steps).
- The indicator indicates the selected mode.

2 Doctor Unit Section

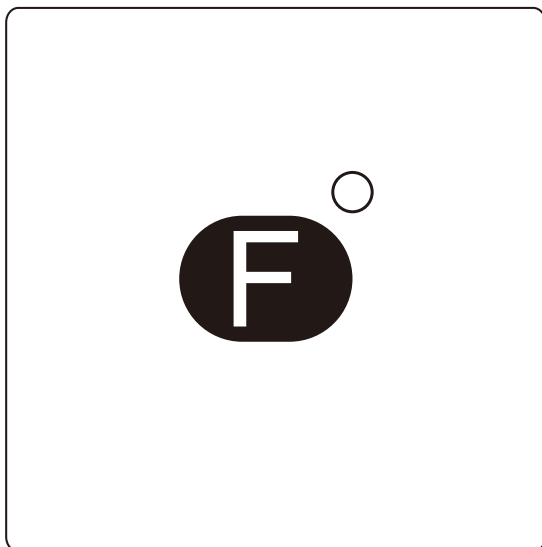

◆ Function switch

- Use this switch for setting various working conditions.

The setup function changes in the sequence indicated below each time when this switch is pressed.

1. Dental timer time setup and motion
2. Doctor number selection
3. Flushout selection and operation
4. Key touch tone selection and change
5. Handpiece light switching-on timing selection
6. Dental timer time-out alarm tone selection
7. Micromotor limit rotation speed selection
8. Micromotor spray mode selection
9. Cupfiller and bowl flush interlocked action selection

○ Function of calculating and displaying the micromotor gear ratio

Pressing and holding the function switch until ' Service mode ' is displayed on indicator, that can be enable or disable the this display function. Refer to page 48 for setting procedure.

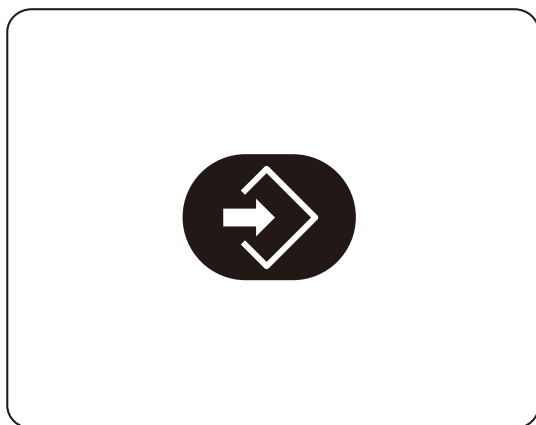

◆ Store switch



- Use this switch for storing data and so forth:

1. Store micromotor preset mode. See page 48 for the setup procedure of micromotor.
2. Store preset timer. See page 44 for the setup procedure.
3. Store micromotor recurrence mode at the time of power on. See page 50 for setup procedure.

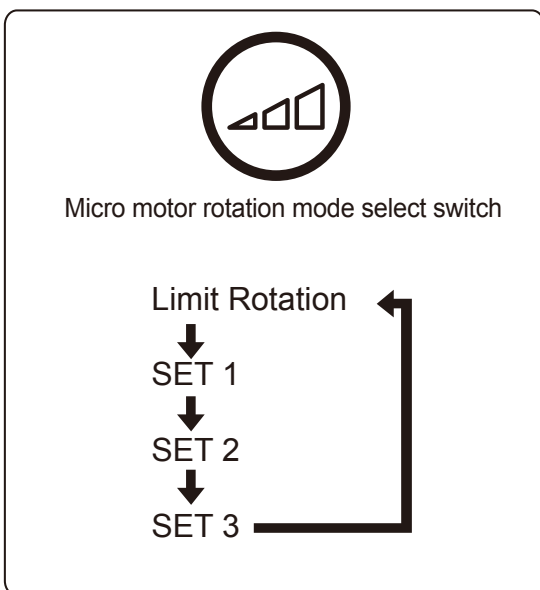
2 Doctor Unit Section



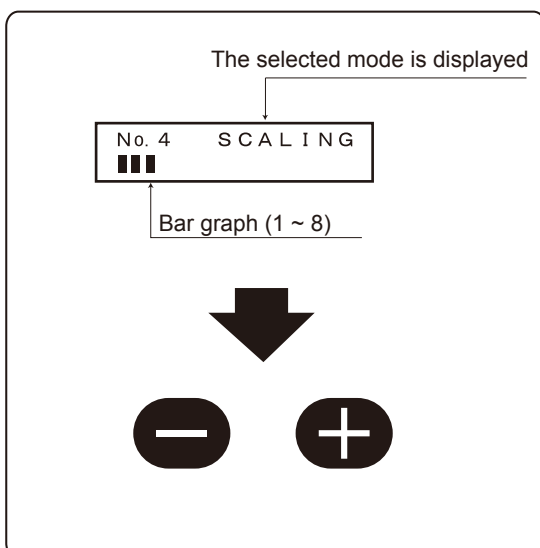

■ Operation and display of micromotor

- There are two modes available, limit rotation (limit mode) and preset rotation (preset mode) for micromotor rotation. Either one of these modes can be selected by pressing this  switch.
- The limit mode is a rotation mode providing an upper limit speed in the rotation.
- The preset mode (SET1 to SET3) keeps the rotation speed fixed regardless how the foot controller is operated.
- Pressing this  switch each time changes the speed mode: Limit speed > SET1 > SET2 > SET3 > Limit speed.



■ Operation and display of scaler

- When the electric scaler is picked up from the holder, the selected mode is displayed on the indicator, either PERIO, ENDO or SCALING. For switching the mode, use the  switch or  switch on the doctor control panel.
- Sliding the foot controller pedal right and left can change the output of the electric scaler. When the pedal slides to the right-hand end, the output becomes the maximum, and the output is displayed by a bar graph on the indicator even before the operation begins.
- * The P-MAX, Varios170 scaler does not permit output change during operation. Once stop the motion, adjust the output, and restart the operation.

NOTICE

Carefully read the appendix of the optional handpiece operating manuals and other documents attached to each scaler before use, and correctly use the scaler.

2 Doctor Unit Section

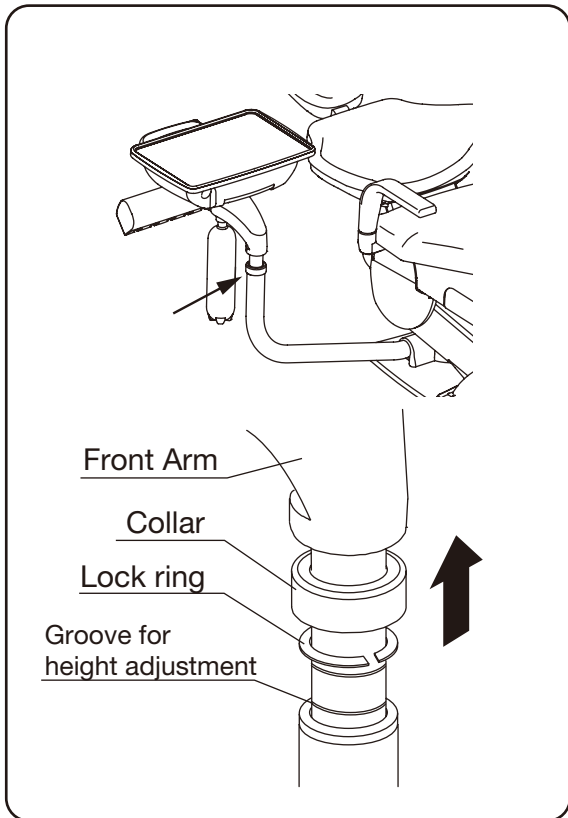

■ Table Height Adjustment

- Hold and slightly lift up the doctor table and front arm, remove the collar to up side, lock ring will come up on the front arm post .
- Slide up or down the lock ring to appropriate groove and slide down the collar on front arm post. Lower the doctor table to fix it at that height.

Please confirm that a table is fixed to the lower course surely then.

⚠ CAUTION

- Turn off the main switch before adjusting table height.
- Be sure to slide down the collar on the lock ring after removing the lock ring.
- Please confirm whether a table is fixed. If the table is not fixed surely, it causes a fall and the accident during operation.

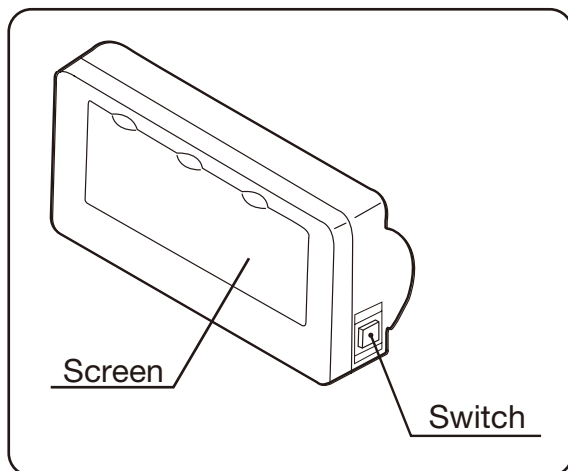

■ Intra-oral size filmviewer (Optional)

- The screen light is lit when the switch is pressed, and the screen light is off when the switch is pressed again.

NOTICE

- Turn off the light when the filmviewer is not in use.
- Dental size film viewer assists the observation of X-rays and it is not used for diagnoses or examination purpose.

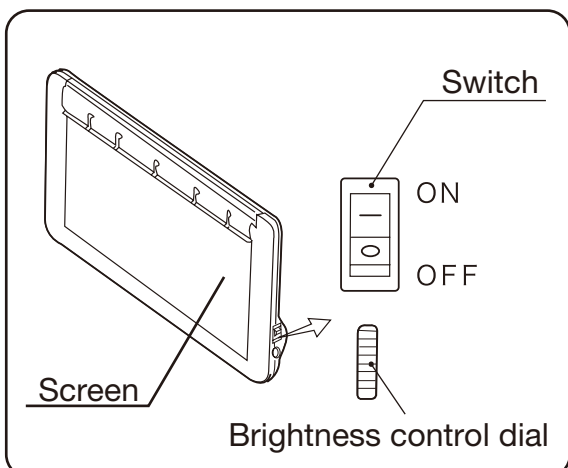

■ Panorama size filmviewer (Optional)

- The screen light is lit when the switch is turned to the upper position (ON), and the screen light is off when the switch is turned to the lower position (OFF).
- The screen brightness increases when the brightness control dial is turned upward, and the screen brightness decreases when the brightness control dial is turned downward.

NOTICE

- Turn off the light when the filmviewer is not in use.
- Panorama size film viewer assists the observation of X-rays and it is not used for diagnoses or examination purpose.

DESCRIPTION OF OPERATION AND FUNCTIONS OF COMPONENTS

2 Doctor Unit Section

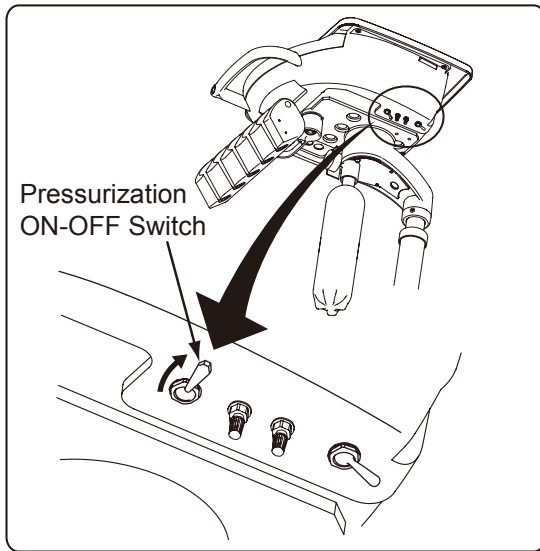

■ Water Tank (Optional)

- Put water into the water tank and it can be supplied water from the water tank.
- When the pressurization ON-OFF switch is moved in the direction of the arrow, the water tank may be used.

⚠ CAUTION

- The water tank is intended only for use with purified water, distilled water and pure water. Do not use mouthwash or electrolyzed water, such as ConCool or povidone iodine, as they may cause clogged tubing or affect internal valves and equipment.
- Adjust the air supply pressure for the water tank to 29 psi or less. An excessively high pressure may cause damage to the water tank.

3 Foot Controller

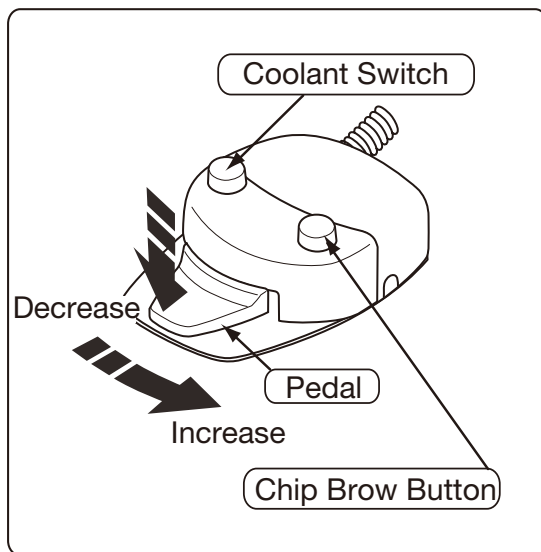

■ Foot Controller (SE Type)

◆ Pedal

- The pedal depressing extent can control the turbine rotation speed and air scaler output.
- The motor rotation is activated when the pedal is depressed. The rotation increases when the pedal is slide to the right, and decreases when the pedal is slide to the left.
- The electric scaler output also increases when the pedal is slide to the right, and decreases when the pedal is shifted to the left. The P-MAX and Varios170 scalers does not permit output control during operation. Once stop the operation, control the output, and restart the operation.

◆ Coolant Switch

- Depressing the coolant switch turns spray on/off like control panel on the table.
- 4-mode (Water > Air > OFF > Spray) operation can be selected for the motor.

◆ Chip Brow Switch

- Chip air for blowing off the chips jets out of the handpiece when the chip blow switch is depressed.

NOTICE

When the foot control pedal is stepped on, the safety function for stopping chair operation is activated.

DESCRIPTION OF OPERATION AND FUNCTIONS OF COMPONENTS

4 Cuspidor Unit Section

■ Maintenance Panel & Cuspidor Control Panel

◆ Standard Package / Cuspidor Package

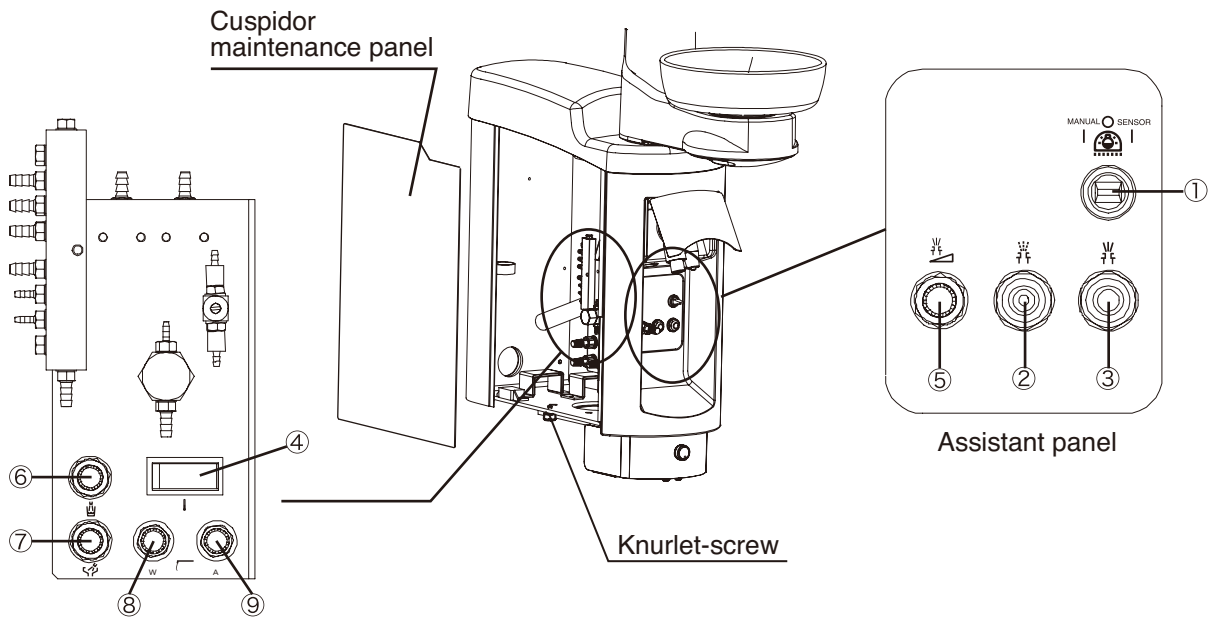

The cuspidor maintenance panel can be opened outward by loosen the knurlet-screw from bottom of the cuspidor unit.

◆ Vacuum Package

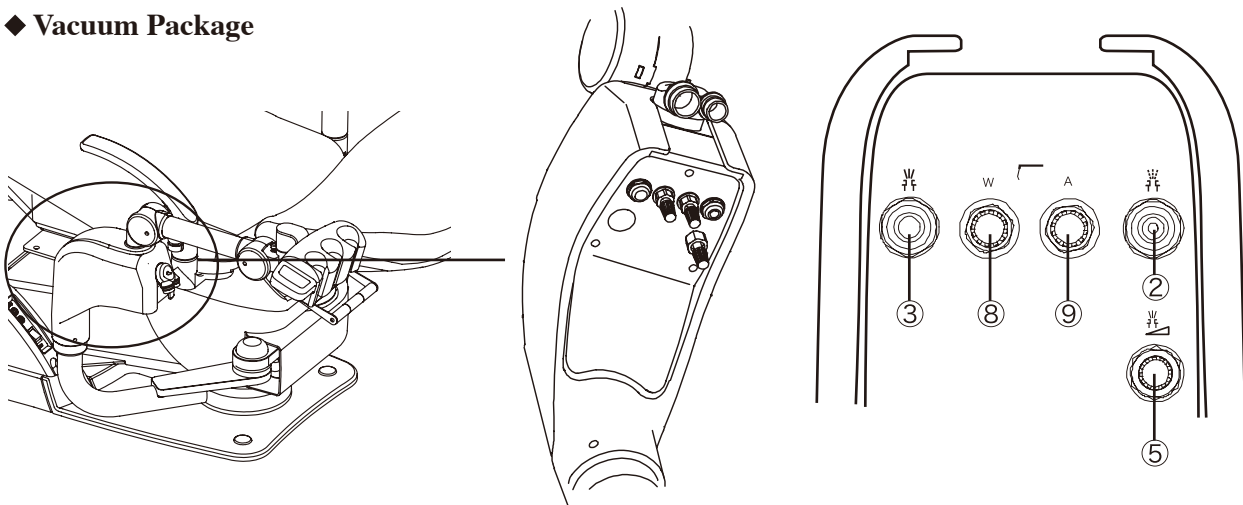

① Dental light select switch

- This switches changes the lighting mode (SENSOR, MANUAL, OFF) of the dental light.
- * There are cases where this switch cannot be used unit specification and the type of dental light.
- SENSOR Mode (Right side) : The dental light can be turned on/off with a touchless switch.
- MANUAL Mode (Left side) : The dental light can be turned on without touchless switch.
- OFF Mode (Center) : The dental light can be off.

DESCRIPTION OF OPERATION AND FUNCTIONS OF COMPONENTS

4 Cuspidor Unit Section

② Service outlet (air) (Optional)

Use this outlet to supply air to external equipment.

③ Service outlet (water) (Optional)

Use this outlet to supply water to external equipment.

④ Water heater switch (Optional)

Switch for turning on/off the cupfiller water heater.

The cupfiller water is heated to warm water when this switch is turned on.

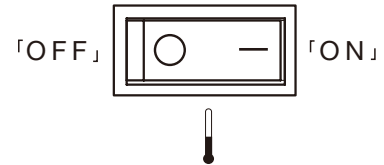

! CAUTION

Make sure that water is poured into the cup before turning on the heater unit in order to prevent the heater unit from heating the cup without water. Heating of an empty water heater may result in burning of the heater.

NOTICE

Water drips from the cupfiller nozzle when the water in the water heater is heated. This phenomenon is not a sign of failure.

⑤ Service outlet water flow control (Optional)

Use this knob to control the water flow rate supplied to outside.

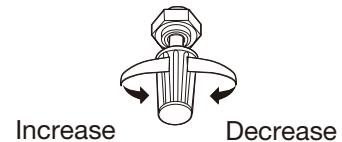

⑥ Cupfiller control knob

This knob adjusts the water feeding quantity. The flow rate decreases when the knob is turned clockwise, and the flow rate increases when the knob is turned counterclockwise.

⑦ Bowl flush control knob

This knob adjusts the flow rate of bowl flush. The flow rate decreases when the knob is turned clockwise, and the flow rate increases when the knob is turned counterclockwise.

⑧ Syringe water control

Make adjustment of syringe water by the syringe water control knob (with blue cap). The flow rate decreases when the knob is turned clockwise, and the flow rate increases when the knob is turned counterclockwise.

⑨ Syringe air control

Make adjustment of syringe air by the syringe air control knob (with yellow cap). The flow rate decreases when the knob is turned clockwise, and the flow rate increases when the knob is turned counterclockwise.

NOTICE

The water and air flow rate control knobs are provided for increasing/decreasing the flow rate, and they are not stop valves. Note that the knobs will become idle if they are shut off too strongly.

4 Cuspidor Unit Section

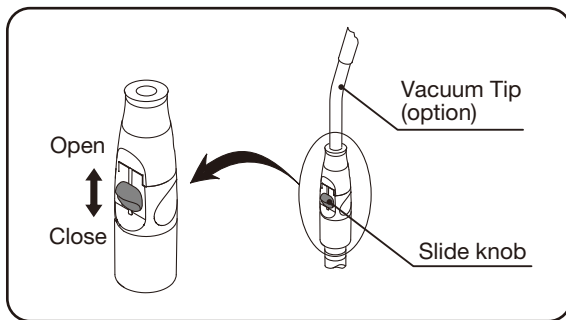

■ Vacuum handpiece

- Suction begins when the vacuum handpiece is taken out of the holder.
- In case of the central vacuum system, suction will not stop immediately after the vacuum handpiece was returned to the assistant holder, but suction will continue for about 3 seconds by the function of delay circuit.
- Opening or closing the slide knob can control the suction flow rate.

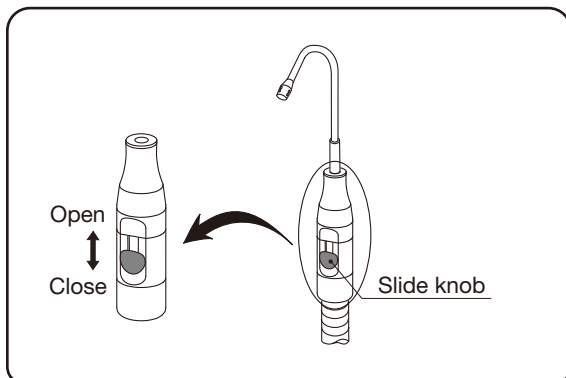

■ Saliva ejector handpiece

- Suction begins when the saliva ejector handpiece is taken out of the holder.
- In case of the central vacuum system, suction will not stop immediately after the saliva ejector handpiece was returned to the assistant holder, but suction will continue for about 3 seconds by the function of delay circuit.
- Opening or closing the slide knob can control the suction flow rate.

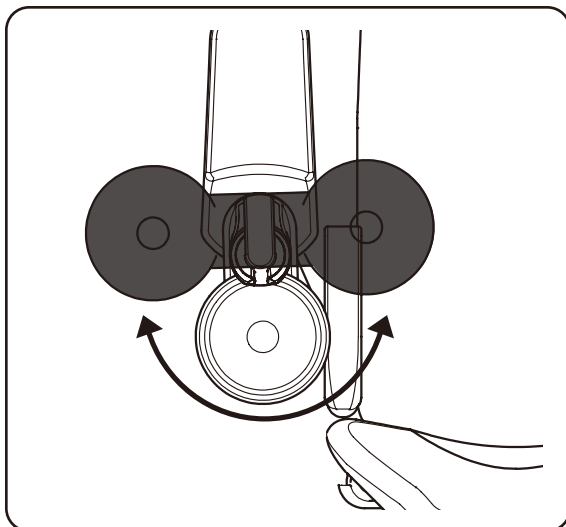

■ Spittoon bowl rotation

- The spittoon bowl turns 180 degrees.

! CAUTION

Make sure that the patient does not lean on the cuspidor unit, as pushing on the spittoon bowl causes it to swing outwards.

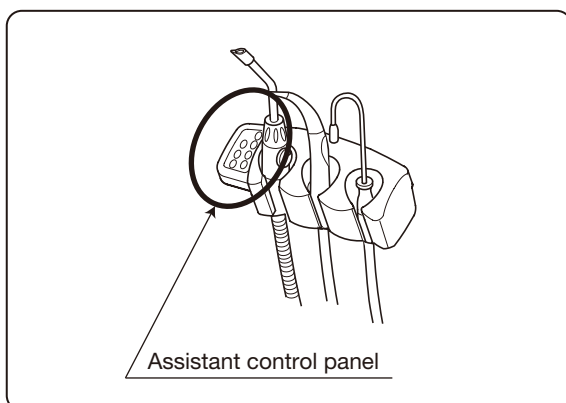

■ Assistant control panel

- The operation and functions of the assistant control panel are the same as those on the doctor control panel in the doctor unit section. See pages 20-22 for the operation procedure.

4 Cuspidor Unit Section

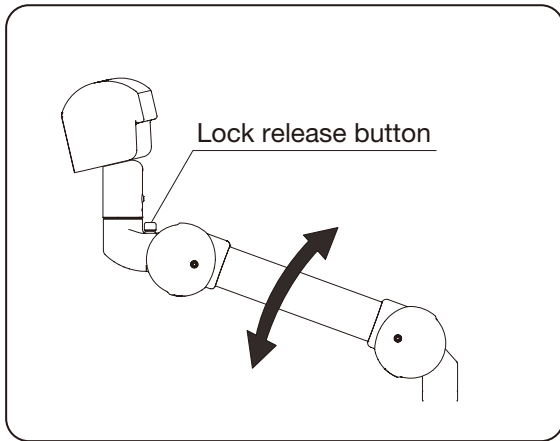

■ Ratchet type assistant arm

Height adjustment of an assistant arm (Optional)

Push up the assistant holder to the desired height position. Press the lock release button and bring down the assistant holder to the desired height and release the lock button.

⚠ CAUTION

Be careful not to pinch your finger when adjusting the assistant holder height.

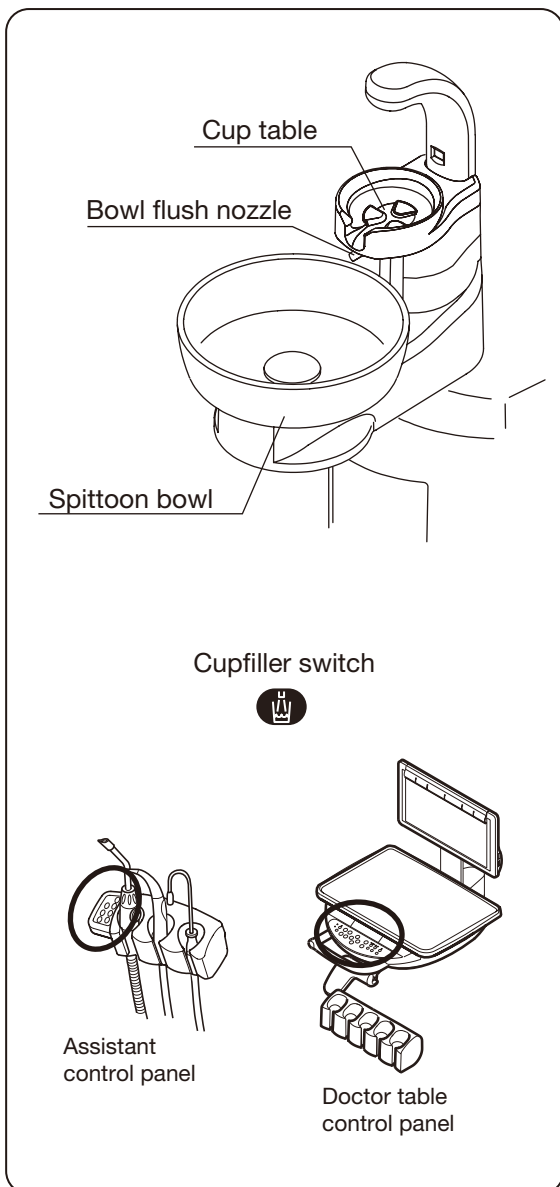

■ Sensor cupfiller (Optional)

- Place the cup (paper cup) on the cupfiller base, water comes out from the cupfiller nozzle, fills up the cup and stops automatically. Press the cupfiller switch  on the doctor or assistant control panel to stop water feeding halfway. When cupfiller starts, the bowl flush also starts, and will run for about 6 sec. and it stops automatically.

- During bowl flush, momentarily press the bowl flush switch  to cancel the bowl flush water flow.

* Use only an empty cup, using a cup with some water left, can cause an over flow.

* The sensor cupfiller needs over 2 seconds interval between cup filling.

⚠ CAUTION

Use only suitable disposable paper cup (dental paper cup 5 oz). Malfunction may arise if the cup is of another material grade (such as stainless steel and plastics) or if the paper cup is of darkcolor or pattern.

Cupfiller sensor may cause incorrect operation when use the crushed paper cup or wet paper cut. please change it to new paper cup.

5 Dental Light Section

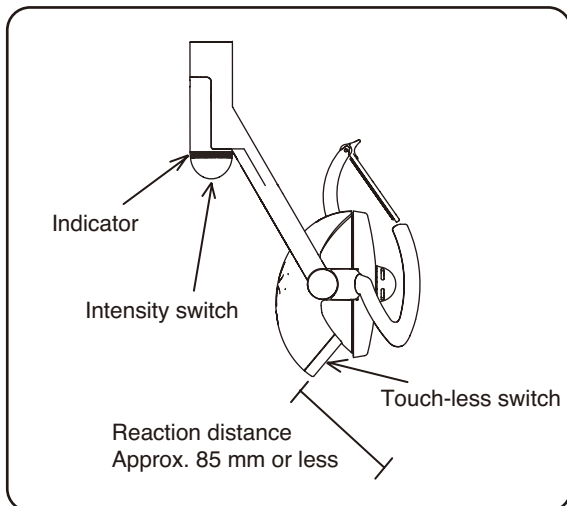

■ 701 dental light (Type AL-720PAS)(Optional)

◆ Main switch and operation switch

- When the main switch of the dental unit is turned on, the indicator shown in the figure is lit in green or orange and the dental light power is turned on.

- The dental light may be turned on and off with the touchless switch or the dental light switch  on the operation panel of the unit side.

◆ Turning on and off of the light by the touch-less switch

- The dental light turned on when you shake your hand within approximately 85 mm from the touchless switch surface. It goes out when you shake your hand again

* If the surface of a touchless switch becomes unclean, this may affect the sensitivity of the sensor.

Please wipe the surface of a touchless switch with a soft cloth.

Mode	Indicator lighting color
HIGH	Green
LOW	Orange



◆ Intensity switch

- This switch changes intensity in the examination mode. Two kinds of intensity are available as shows on the left.

- The intensity changes when you press up the rubber cover of the intensity switch from below.

Mode	Indicator blinking color
COMPOSITE	Green or orange

◆ Changing into composite mode

- The indicator begins to blink in green and the mode changes to the composite mode, when you hold your hand within 85mm from the touchless switch for 2 seconds or keep pressing dental light switch  on the control panel for 2 seconds. The indicator is lit in green and the mode changes to the treatment mode, when you leave your hand once and hold it above the switch again for 2 seconds or keep pressing dental light switch  on the control panel for 2 seconds.

*When the light is turned off in the composite mode, it goes on in the treatment mode when it is turned on again.

5 Dental Light Section

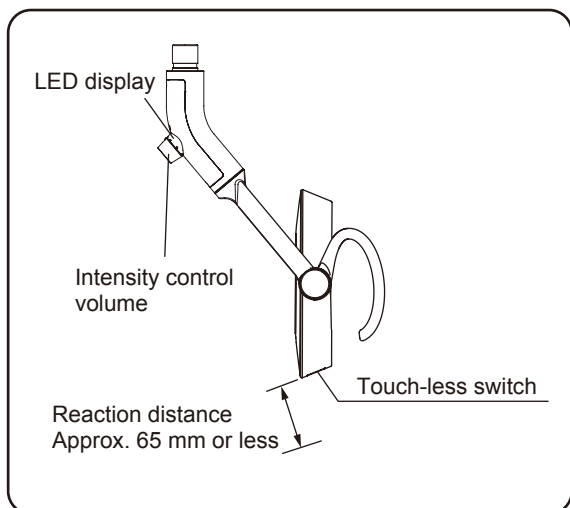

900 dental light (Type AL-920PAS)(Optional)

◆ Main switch and operation switch

- When the main switch of the dental unit is turned on, the indicator shown in the figure is lit in green and the dental light power is turned on.
- The dental light may be turned on and off with the touchless switch or the dental light switch  on the operation panel of the unit side.

◆ Turning on and off of the light by the touch-less switch

- The dental light turned on when you shake your hand within approximately 65 mm from the touchless switch surface. It goes out when you shake your hand again
- * If the surface of a touchless switch becomes unclean, this may affect the sensitivity of the sensor. Please wipe the surface of a touchless switch with a soft cloth.



	LED display
Normal treatment mode	Light On (Green)

◆ Intensity control volume

- It can adjust intensity between 4,000 ~ 35,500lx by stepless intensity control volume as left figure.

	LED display
Composite mode	Blinks (Green)

◆ Changing into composite mode

- The indicator begins to blink in green and the mode changes to the composite mode, when you hold your hand within 65mm from the touchless switch for 2 seconds or keep pressing dental light switch  on the control panel for 2 seconds. The indicator is lit in green and the mode changes to the treatment mode, when you leave your hand once and hold it above the switch again for 2 seconds or keep pressing dental light switch  on the control panel for 2 seconds.
- *When the light is turned off in the composite mode, it goes on in the treatment mode when it is turned on again.

5 Dental Light Section

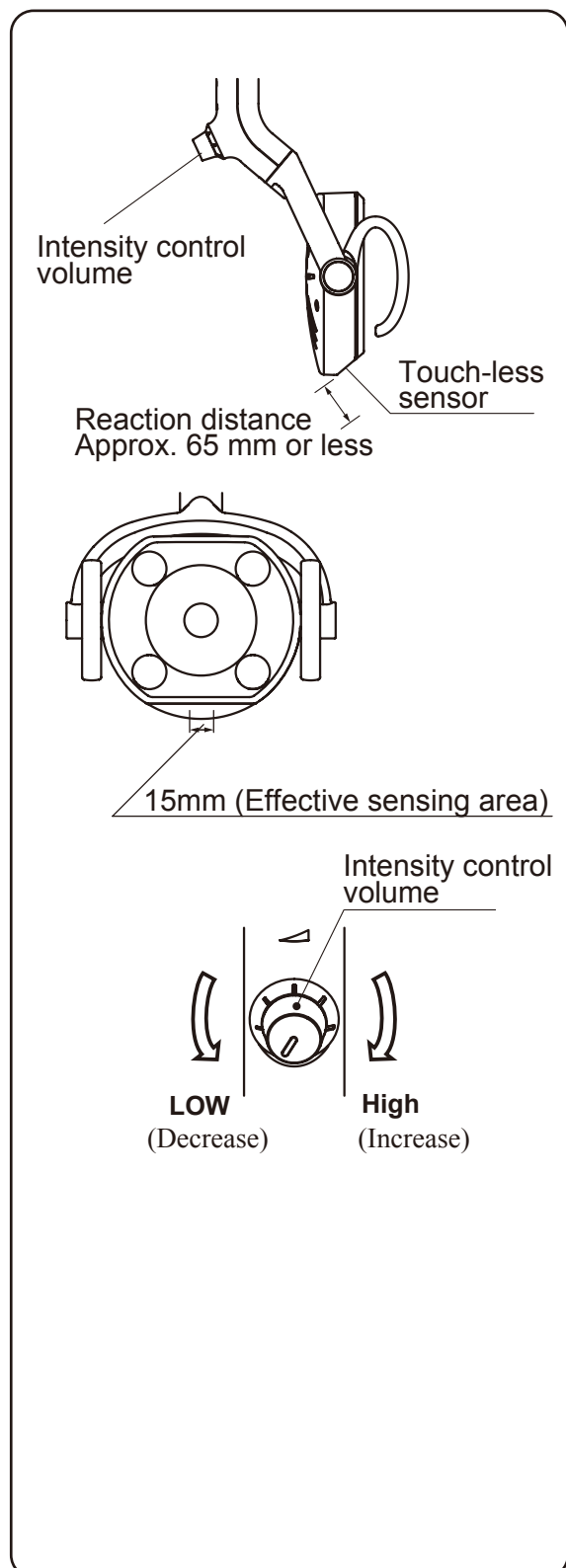

■ 300LED dental light (Type AL-320PAS)(Optional)

◆ Main switch and operation switch

- When the main switch of the dental unit is turned on, the dental light power also turned on.

- The dental light may be turned on and off with the touchless switch or the dental light switch  on the operation panel of the unit side.

◆ Turning on and off of the light by the touch-less switch

- The light can be turned on/off with a touchless sensor. (Effective sensing area is 65mm depth, 15mm width). Pass your hand by touchless sensor within effective sensing area to turn on and pass your hand again to turn off.

* If the surface of a touchless switch becomes unclean, this may affect the sensitivity of the sensor.

Please wipe the surface of a touchless switch with a soft cloth.



◆ Intensity control volume

- It can adjust intensity between 3,100 ~ 28,000lx by stepless intensity control volume as left figure.

- The intensity is increased by turning intensity control volume clockwise. It is decreased by turning the intensity control volume counterclockwise.

- During composite mode, intensity can't be adjusted.

◆ Changing into composite mode

- During normal treatment mode, while the light is on, place and hold your hand by touchless sensor within effective sensing area for certain time or keep pressing dental light switch  on the control panel for certain time. The light intensity will be automatically reduced to the composite mode. To switch back to the normal treatment mode, place your hand by the touchless sensor for certain time again or keep pressing dental light switch  on the control panel for certain time.

* When the light is turned off in the composite mode, it goes on in the normal treatment mode when it is turned on again.

6 Right/Left handed dentistry conversion

■ Please confirm before convert to right or left handed position

- Bring the chair to the upper position and backrest upright position.
- Turn off the main switch for safety.
- Confirm that there are no obstacles around this product.

! CAUTION

Take care not to contact other people or obstacles to the unit during the work. It may cause damage the unit or physical injury.

■ Right/Left handed dentistry conversion

Example : Change Right handed position to left handed position for standard package.

- ① Swing the assistant holder to behind the backrest as shown on the left figure

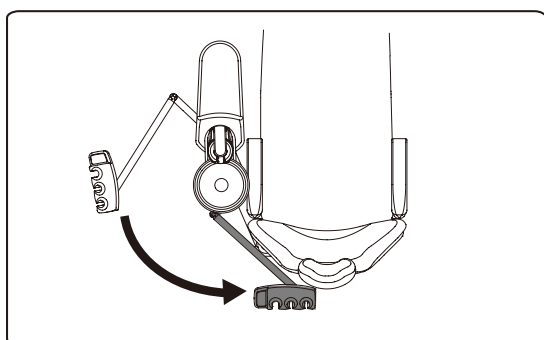

! CAUTION

Take care not to pinch the vacuum hose and saliva ejector hose between the assistant arm and the cuspidor swing arm during this work.

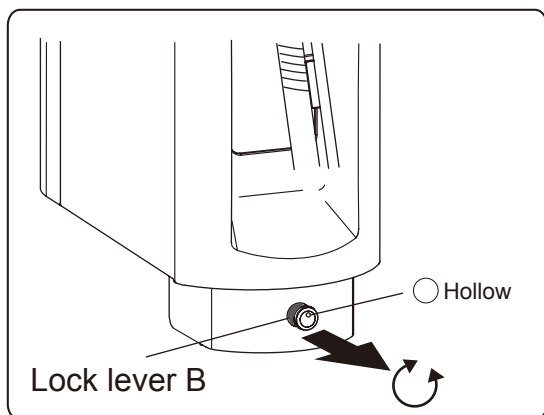

- ② Pull forward the lock lever B on the bottom of the cuspidor unit until see the red painted portion, then turn it and change the position of hollow on the lock lever B to upper side as .

NOTICE

When the lock lever B is difficult to pull. At that time, pulling forward the lock lever with adjust the position of the cuspidor body.

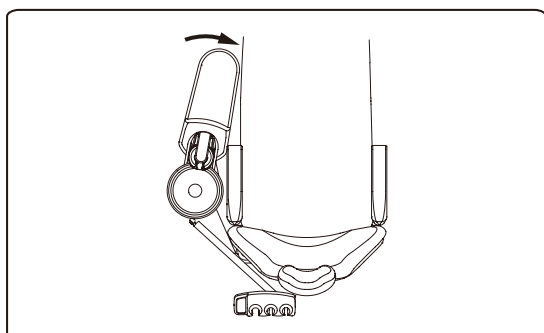

- ③ Move the cuspidor to chair side as shown on the left figure.

6 Right/Left handed dentistry conversion

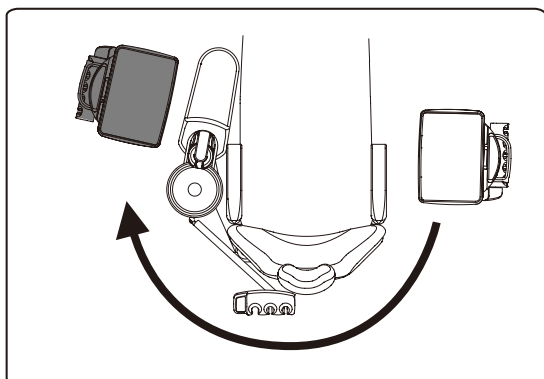

- ④ Swing the doctor table to the cuspidor side as shown on left figure.

! CAUTION

Be carefully when moving the doctor table. Not to contact the doctor table with the cuspidor unit.

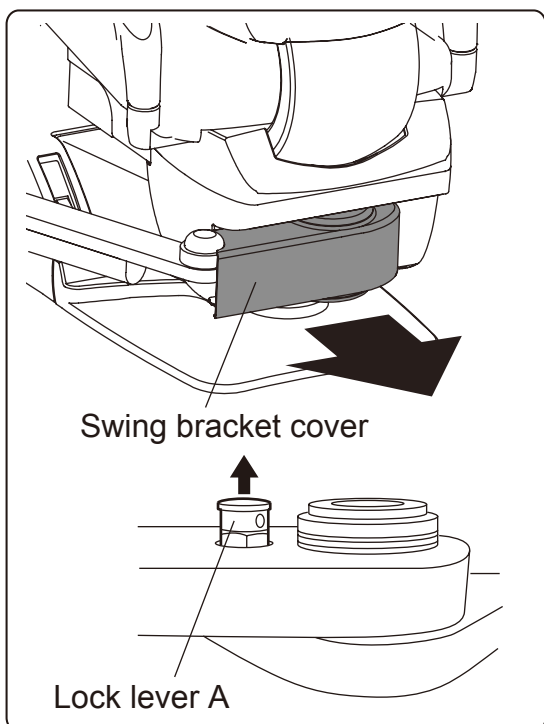

- ⑤ Remove the swing bracket cover by pulling as direction of the arrow from behind the chair. Pull up the lock lever A on the swing arm, then swing the swing arm slightly to outside. The lock lever A become a unlock position and be able to move the swing bracket.

NOTICE

When the lock lever A is difficult to pull up. At that time, pulling up the lock lever, then adjust the position of the swing bracket to make easier to pull out the lock lever A.

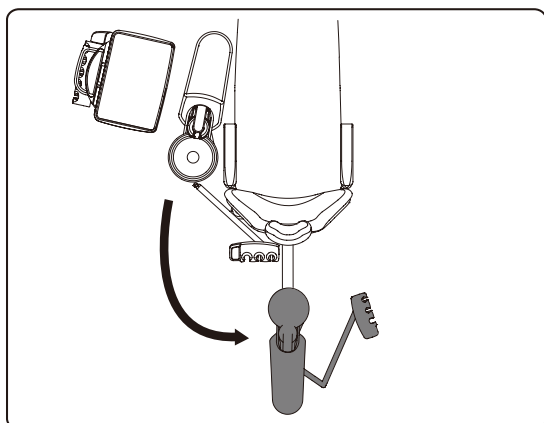

- ⑥ Swing the cuspidor unit to behind the chair as shown on the left figure.

! CAUTION

Be carefully when moving the cuspidor unit. Not to contact the cuspidor unit with the doctor table.

DESCRIPTION OF OPERATION AND FUNCTIONS OF COMPONENTS

6 Right/Left handed dentistry conversion

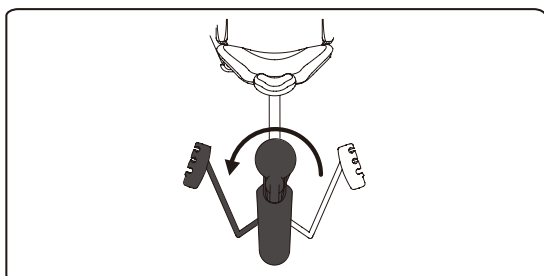

⑦ Switch the position of the assistant holder to other side.

At that time, the vacuum hose and saliva ejector hoses may be twisted. Remove the hoses from the holder and reattach it again.

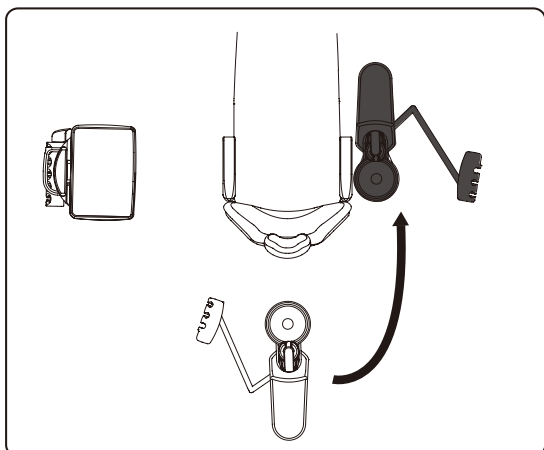

⑧ Swing the cuspidor unit and the assistant holder as shown on the left figure. When the cuspidor unit moved to correct position as shown on the left figure, the lock lever A on the swing bracket can be locked automatically.

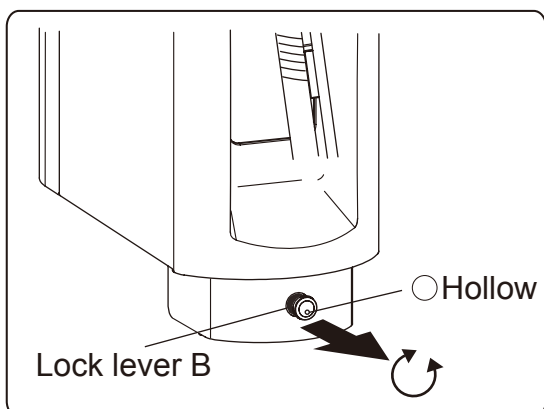

⑨ Turn the lock lever B to change the position of hollow to down side. Move the cuspidor unit in left or right lightly until make sure the lock lever B is return to lock position.

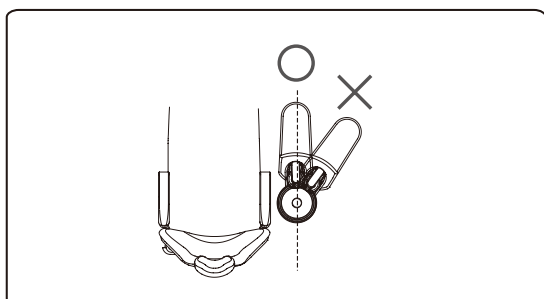

NOTICE

There are two locked positions of cuspidor unit as shown on the left figure. The cuspidor locked position must be parallel to the chair.

6 Right/Left handed dentistry conversion

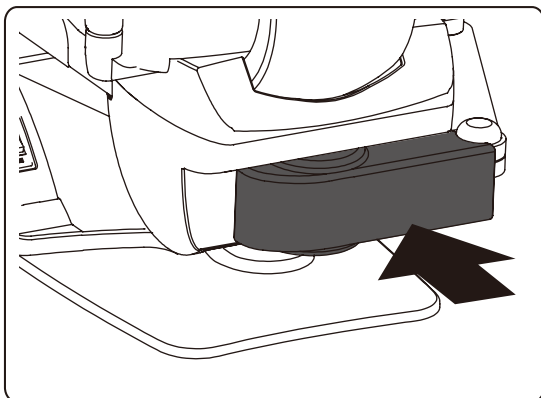

⑩ Attach the swing bracket cover to swing bracket.

NOTICE

The swing bracket cover is same for left and right.
Turn it upside down and attach to it.

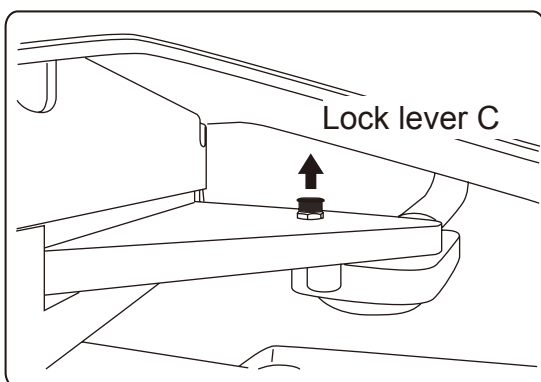

⑪ Pull the lock lever C on the swing arm bracket, then swing the light pole slightly to chair legrest side.

NOTICE

When the lock lever C is difficult to pull up. At that time, pulling up the lock lever, then adjust the position of the light pole to make easier to pull out the lock lever C.

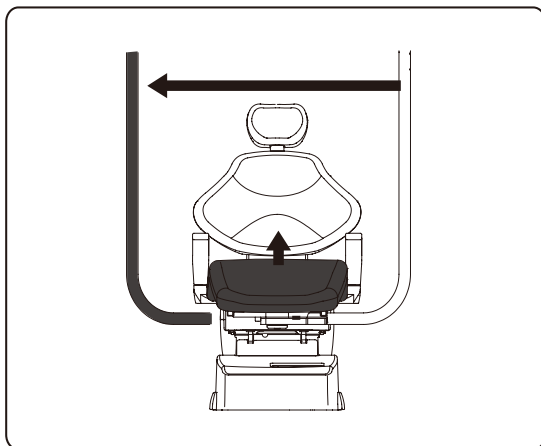

⑫ Lift the toe board of seat cushion and swing the light pole to other side as shown on the left figure.

When the light pole moved to correct position, the lock lever C on the swing bracket can be locked automatically.

DESCRIPTION OF OPERATION AND FUNCTIONS OF COMPONENTS

6 Right/Left handed dentistry conversion

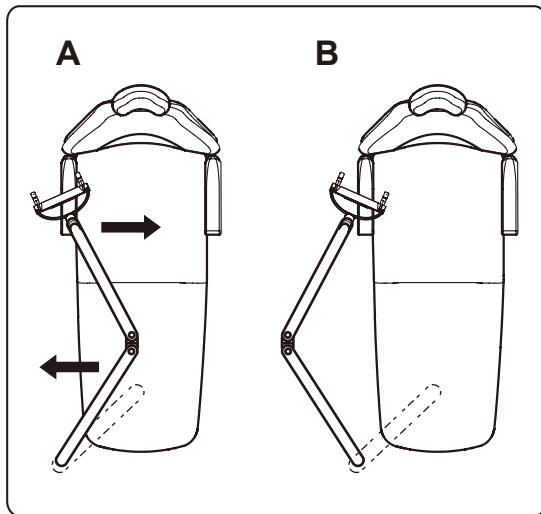

⑬ After moved the light pole, the balance arm position become A position as shown on the left figure. Adjust the position of the balance arm to position B as shown on the left figure.

After this conversion, be sure to confirm the safety function has been working properly. Please refer to the next page.

DESCRIPTION OF OPERATION AND FUNCTIONS OF COMPONENTS

6 Right/Left handed dentistry conversion

■ Confirm the safety function

For safe use of this product, Please confirm safety function as follows after every this conversion.

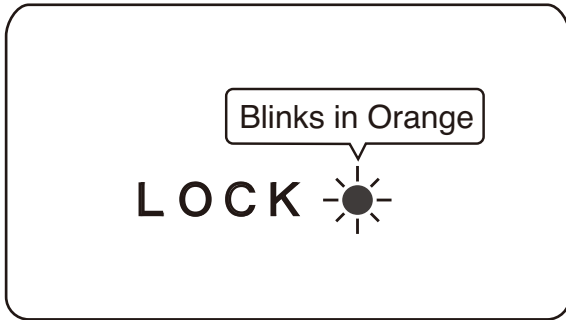

The safety mechanism that inhibits chair motion works while of the following actions is taken. The "LOCK" LED indicator lamp is lit in orange in this state on the doctor control panel. Refer to page_51 for chair motion stop function.

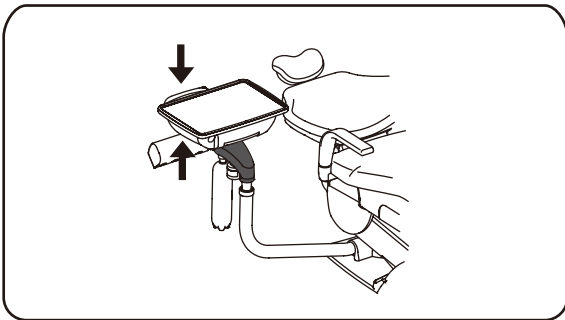

If excess pressure (upward or downward) is applied to the doctor table by the movement of chair, safety device stops the chair movement to protect the table from being damaged.

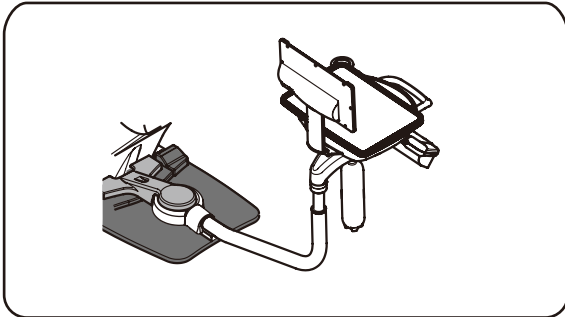

When the doctor table is turned to the back side of the backrest and chair auto motion of the chair is locked

1 Chair Auto Operation Setting

Set the treatment position by chair manual switch

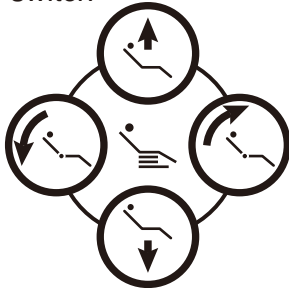

Keep pressing preset switch to be set for about 5 seconds



or



Autoreturn switch

Move the chair to rinsing position by chair manual switch

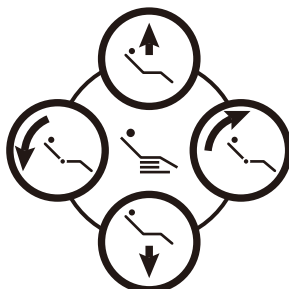

Keep pressing LP for about 5 seconds



■ Preset position setup procedures

1. Move the chair to the treatment position using manual switches.
2. Upon deciding of the desired treatment position, keep pressing preset switch , ① ② or ① to be set for about 5 seconds. The buzzer sounds from the chair, and setup has been completed.
3. To change the set position, perform the procedures steps 1 and 2 above.

■ Last position setup procedures

1. Move the chair to the rinsing position using manual switches.
2. Upon deciding the desired rinsing position, keep pressing last position switch (LP) for about 5 seconds. The buzzer sounds from the chair, and setup has been completed.
3. To change the set position, perform the procedures steps 1 and 2 above.

OPERATION SETTING

2 Doctor Unit Section

■ Contents and sequence of function switch

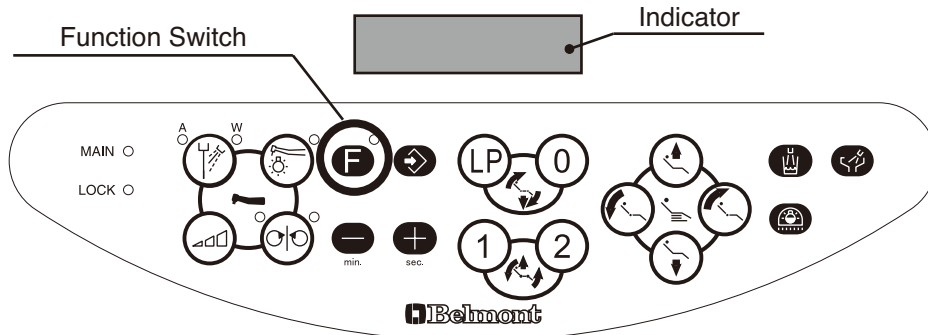

- The contents of display on the indicator on the doctor control panel change sequentially each time when the function switch is pressed to select a desired setup. Contents and sequence of function switch setup are described below.

①	TIMER SET F = ↓ ▲ = START	① Setup and operation of dental timer
②	Dr NUMBER = 0 ↓	② Selection of doctor number
③	FLUSH OUT F = ↓ (-) = HP (+) = HP +	③ Selection and operation of flushout
④	BEEP=ON F = ↓ (-) = OFF (+) = ON (Example) Case of "with switch tone"	④ Selection and change of key touch tone
⑤	LP. MODE=HOLD F = ↓ (-) = FOOT (+) = HOLD (Example) Case of holder mode	⑤ Selection of handpiece light switching-on timing
⑥	ALARM TYPE = 0 F = ↓ 0 1 2 LP (3) PUSH	⑥ Selection of alarm tone upon time-up of dental timer
⑦	M LMT= 3 STEP F = ↓ (-) = 3 (+) = 5 STEP	⑦ Selection of number of steps of micromotor limit rotation speed
⑧	SPRAY= 4 MODE F = ↓ (-) = 2 (+) = 4 MODE	⑧ Selection of micromotor spray mode
⑨	* = LINK F = E (-) = IND (+) = LINK	⑨ Selection of interlocked action of cupfiller and bowl flush
⑩	BELMONT	⑩ Return to normal action.

* Normal action is restored during setup if the next operation is not applied within about 10 seconds.

2 Doctor Unit Section

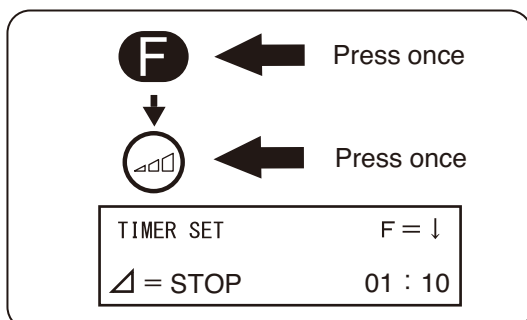
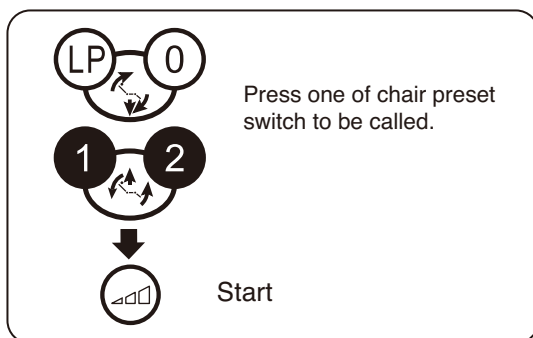
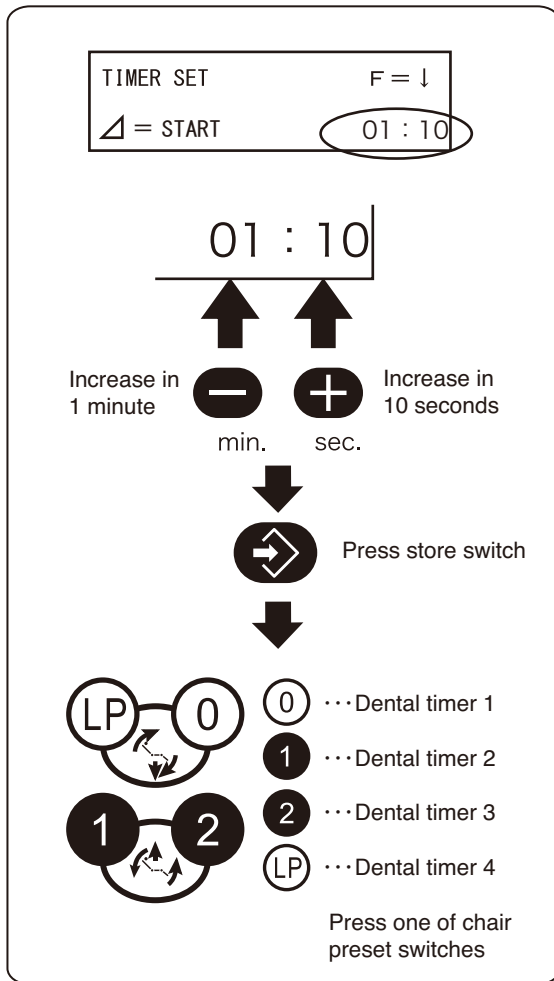

① Setup of dental timer and operation

- A countdown timer is built in to the unit and can be set to a maximum timer of 90 minutes and 50 seconds in 1 minute or 10 second increments.
- The timer has 4 programmable settings, which can be recalled when used in conjunction with the chair preset switch (0) (1) (2) (LP) on doctor table control panel.

[Procedure for setup of preset timer]

1. Press the function switch **F** once.
2. Set the desired time.
 Increase in 1 minute by pressing ... **-** switch
 Increase in 10 seconds by pressing ... **+** switch
 Note : Time increases continuously when the **-** switch or **+** switch is pressed and held
3. Press store switch **↔**.
4. Press one of chair preset switches (0) (1) (2) (LP) to store the set timer to a particular preset number.

- * When change the preset time or set the timer to other preset number, repeat the procedures 1 ~ 4.
- * Setting time is only the addition. Time increases continuously when switch is pressed and held.
- * The factory default setting is 3 minutes for (0), 1 minute for (1), 2 minutes for (2) and 5 minutes for (LP).

[Procedure for use of preset timer]

1. Press the function switch **F** once.
2. Press the chair preset switch (0) (1) (2) or (LP) to be called.
3. Start the timer by pressing rotation mode select switch **⏸**
4. When the timer time is reduced to 00:00, the alarm sounds to inform that the set length of time has elapsed.

[Timer cancellation]

- This is the procedure for cancellation of the dental timer during countdown action.
1. Press the function switch **F** once.
 2. Press rotation mode select switch **⏸** to cancel the timer.

2 Doctor Unit Section

Dr NUMBER= 0 ↓

- 0 . . . Doctor Number = 0
- 1 . . . Doctor Number = 1
- 2 . . . Doctor Number = 2
- LP . . . Doctor Number = 3

② Selection of doctor number

- Chair positions and handpiece initial setup for four different doctors can be stored.
 - Micromotor preset rotation speed, and on/off status of light pack and spray. (3 positions per each doctor)
 - Micromotor motion state at the time of power on, and dental light switch on/off state.
 - Chair preset position. (Up to 3 positions for each doctor)
 - Dental light intensity. (2 positions, that is, high/low, for each doctor)
 - Dental timer preset time.
 - Light pack residual lighting time.
- * If you want to change setup of the light pack residual lighting time, please contact your dealer or our office.

[Procedure for setup]

1. Press the function switch twice.
2. Press one switch from ○ 0 ● 1 ● 2 ○ LP for selection.

FLUSH OUT F = ↓
 (-) = HP (+) = HP+

After operation of 1. and 2. ↓ min.

(Example) Case of full flushout of HP

PUSH FOOT PEDAL
 1 2 3 4 F ▶ 00 : 40

The ID number of the picked up HP is displayed. (HP numbers are 1, 2, 3 and 4 from front left.)

The residual time is displayed. (Starts from 40 seconds.)

FLUSH OUT F = ↓
 (-) = HP (+) = HP+

After operation of 1. and 2. ↓ sec.

(Example) Case of full flushout of HP

PUSH FOOT PEDAL
 1 2 3 4 F ▶ 05 : 00

The residual time is displayed. (Starts from 5 minutes, and after termination of handpiece flushout, starts from 5 minutes again.)

Cupfiller Nozzle
Bowl Flush Nozzle

Pedal

③ Selection and operation of flushout

[Procedure for operation]

Mode I. Case of flushout of handpiece water line only

1. Press the function switch three times.
2. Press the switch.
3. Pick up the handpiece to be flushed, and set it over the cuspidor bowl or the like.
4. Depress the foot controller pedal. Then release the pedal, and the water jets out of the handpiece for 40 seconds .

Mode II. Case of flushout of cupfiller and cuspidor bowl after termination of handpiece flushout

1. Press the function switch three times.
2. Press the switch.
3. Pick up the handpiece to be flushed, and set it over the cuspidor bowl or the like.
4. Depress the foot controller pedal. Then release the pedal, and the water jets out of the handpiece for 5 minutes. On termination of handpiece flushout, water is delivered out of the cupfiller and cuspidor nozzles simultaneously for 5 minutes for cuspidor bowl flushout.

* To stop flushout action in mid-way, press any switch or depress the foot controller pedal.

* Normal action is restored unless the or switch is pressed within about 10 seconds after the function switch was pressed.

2 Doctor Unit Section

BEEP=ON F = ↓
 (-) =OFF (+) =ON

(Example) Case of with switch tone

Tone off





min.

Tone on

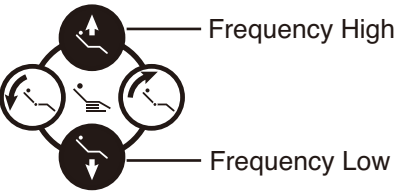

sec.





Return to initial setup



sec.

Press once
(Be sure to press this switch after setting)





④ Selection and change of key touch tone

With or without beep tone that is issued when a switch is pressed can be selected, and the beep tone frequency (tone quality) can be changed.

(It is not possible to control the volume of the selected frequency.)

[Procedure for setup]

1. Press the function switch four times.
2. Press the relevant setup switches from the following.

- To turn off the tone ----- 
- To sound the tone ----- 
- To increase the frequency ----- 
- To decrease the frequency ----- 
- To change the frequency to initial setup -- 

[Precautions for change to frequency]

- Ensure to press the  switch on finishing the frequency change.
- The contents of frequency setup are not displayed on the indicator. However, the switch tone sounds each time when the frequency is changed. Confirm the frequency change by hearing the tone.

LP. MODE=HOLD F = ↓
 (-) =FOOT (+) =HOLD

(Example) Case of holder mode

Rotation mode



min.

Holder mode



sec.

⑤ Selection of handpiece light on timing

The handpiece light on timing can be selected from the two mode.



1) Rotation mode (FOOT)

The light is turned on while the handpiece is running, and is off upon elapse of the set light remaining time after termination of handpiece running.

2) Holder mode (HOLD)

The light is turned on when the handpiece is picked out of the holder and will turn off when returned to the holder.

[Procedure for setup]

1. Press the function switch five times.
 2. Press the desired setup switch.
- Rotation mode -----  switch
 - Holder mode -----  switch

2 Doctor Unit Section

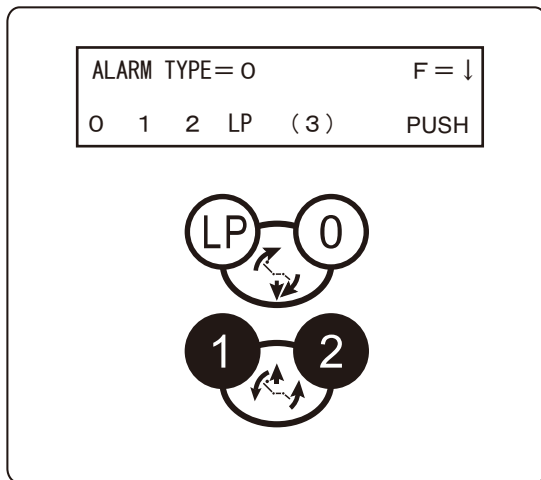

⑥ Selection of alarm sound for dental timer

- The alarm sounds on termination of timer time after countdown of dental timer.
- Four alarm patterns are provided, and even in case where multiple chairs are installed in the same room, the chair from which the alarm sounds can be easily identified if different alarm patterns are set.

[Procedure for setup]

1. Press the function switch six times.
2. Press a desired chair setup switch from 0 1 2 LP.

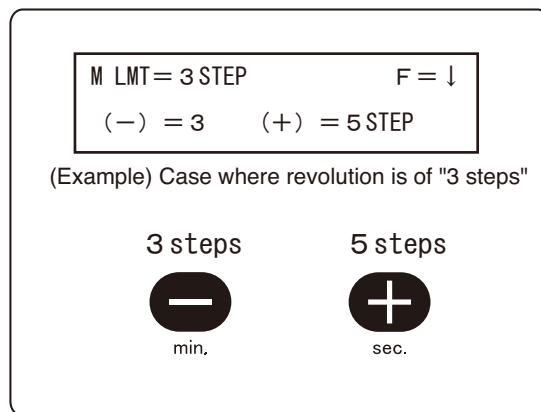

⑦ Selection of number of steps of micromotor limit rotation

- The number of steps of micromotor limit rotation can be selected from 3 steps and 5 steps.

Case of 3 steps

10000 / 20000 / 40000 min⁻¹(rpm)

Case of 5 steps

5000 / 10000 / 20000 / 30000 / 40000 min⁻¹(rpm)

(The rotation values indicated above are given for reference only.)

[Procedure for setup]

1. Press the function switch seven times .
2. Press the desired setup switch.
 - 3 steps --- switch
 - 5 steps --- switch

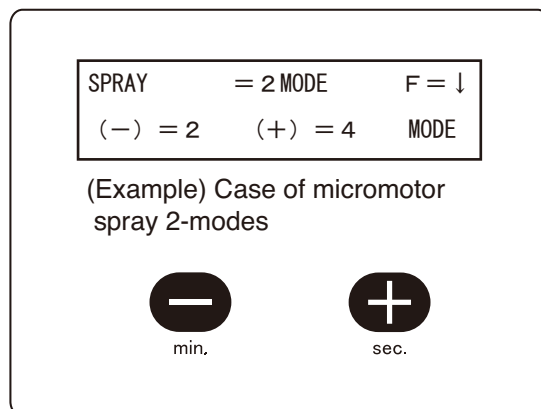

⑧ Selection of micromotor spray mode

Case of 2 modes

Micromotor spray on/off only.

Case of 4 modes

Micromotor spray on/off, water only and air only.

[Procedure for setup]

1. Press the function switch eight times.
2. Press the desired setup switch.
 - 2 modes --- switch
 - 4 modes --- switch

2 Doctor Unit Section

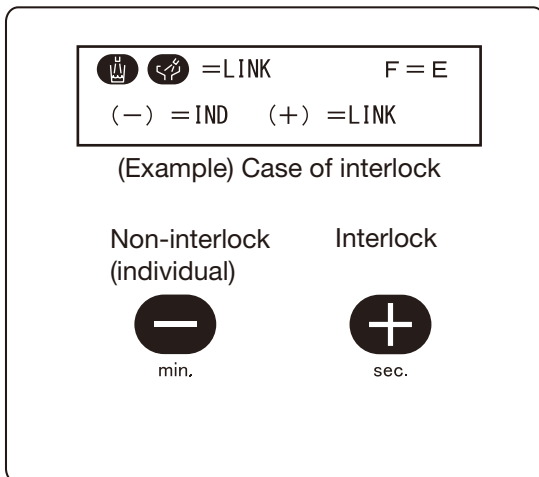

⑨ Selection of interlocked action of cupfiller and bowl flush

• Selection is permitted from two procedures.

Ⓒ Case of non-interlock

Flushout of the cuspidor bowl is not implemented even after start-up of cupfiller.

Ⓒ Case of interlock

Flushout of the cuspidor bowl is implemented simultaneously with start-up of cupfiller.

[Procedure for setup]

1. Press the function switch nine times.

2. Press the desired setup switch.

Ⓒ Non-interlock --- switch

Ⓒ Interlock ----- switch

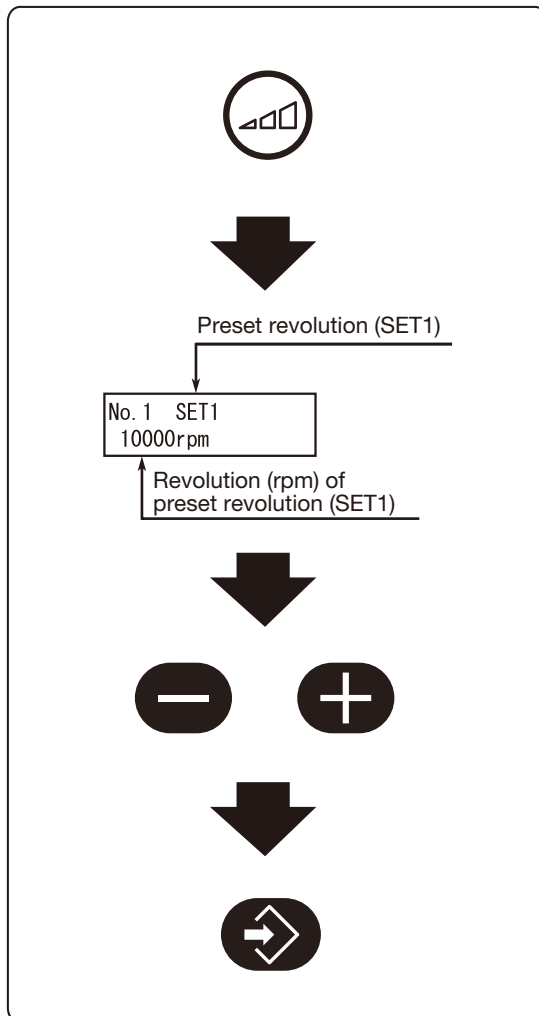

■ Setup of micromotor preset mode

• The micromotor preset mode causes the micromotor to run at a preset rotation regardless of the foot controller pedal depressing extent.

The micromotor preset mode permits memory setup of SET1 to SET3.

[Procedure for setup]

1. Pick up a micromotor from the holder.

2. For memory setup of preset mode SET1, press rotation mode select switch until SET1 is displayed on the indicator.

3. SET1 is displayed on the indicator, and at the same time, the rotation set in SET1 is displayed.

The micromotor runs at this displayed rotation (value for reference).

4. To change the rotation, press the switch or switch. The numerical value displayed on the indicator changes.

5. To store the rotation after change, press the switch. The set value before change is restored if the main switch is off without pressing this switch.

6. Memory setup of each of preset mode SET2 and SET2 can be implemented by observing the procedure described in step 2 and subsequent above.

CAUTION

Do not change the rotational speed while the micromotor is running.

2 Doctor Unit Section

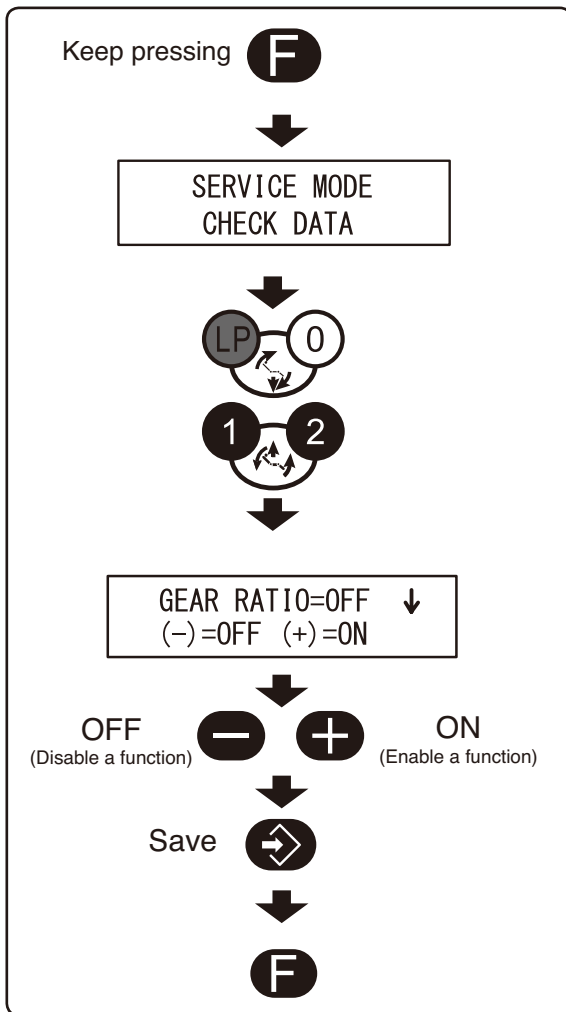

■ Function of calculating and displaying the micromotor gear ratio

- This setting function converts the gear ratio of the contra-angle handpiece to be mounted to the micromotor and displays values near the actual revolutions.
- Five gear ratios are converted: $\times 5$, $\div 4$, $\div 16$, $\div 64$ and $\div 128$.

[Procedure for enable or disable of display function]

1. Keep depressing function switch **F** on doctor control panel until "SERVICE MODE" is displayed on the indicator.
2. Press LP switch **LP** once.
3. Press the desired setup switch.
 - Enable a display function ----- **+**
 - Disable a display function ----- **-**
4. Press the store switch **↔** once to save it.
5. Press the function switch **F** once after setting.

[Note] The factory default setting is disable for this function.

* Press function switch **F** to escape from service mode.

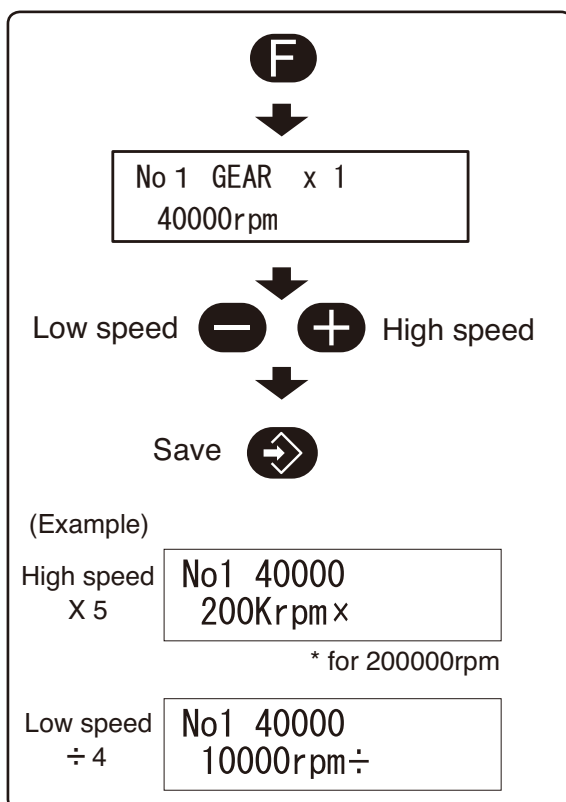

[Operation procedures]

1. Pick up a micromotor from the holder and press function switch **F** once. (Do not keep holding down this switch)
Displayed on the indicator as shown on the left figure.
(Displayed as GEAR x 1 is constant-speed mode)
2. Press the **-** or **+** switch to select gear ratios.
 - High speed ----- **+**
 - Low speed ----- **-**
3. Press the store switch **↔** to save it. During the setting, press the function switch **F** once to cancel the setting.

- This function is working properly, when X (High speed) or \div (low speed) is displayed on the indicator.
- When high speed (X5) is selected, K is displayed on the indicator instead of 1000rpm.
- When the main switch is turn off, the gear ratio setting becomes constant speed (X1).

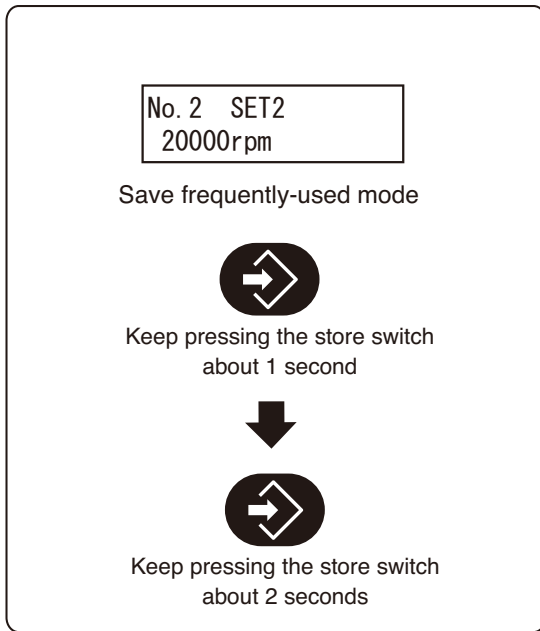

2 Doctor Unit Section



◆ Description of recurrence mode at the time of power on and setup

- This recurrence mode is the rotation mode that always appears first when a micromotor is picked up after the main switch is turned on.
- It is convenient if a rotation mode frequently used is set as the recurrence mode.

[Procedure for setup]

1. Turn on the main switch, and pick up a micromotor from the holder.
2. Press the rotation mode select switch  and select a desired rotation mode (limit mode or preset mode) to be set.
3. Press the store switch  for about 1 second.
4. Press the store switch  for about 2 seconds and the buzzer sounds to confirm that setup of the selected rotation mode has been completed.

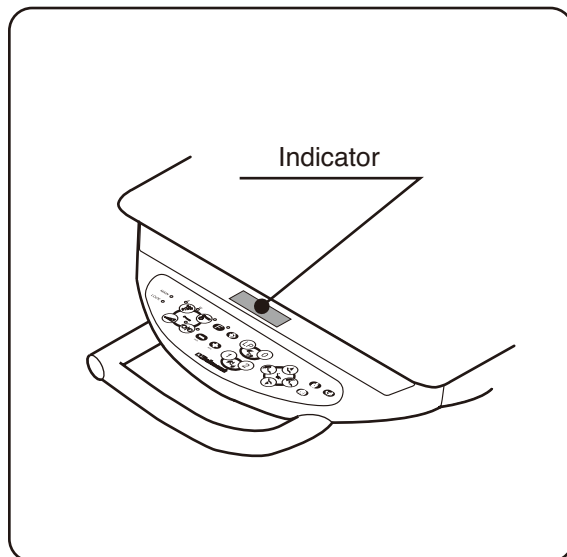

■ Indicator off function

- The indicator is off if no operation is performed for a fixed length of time. This function is provided for preventing fluorescent lamp seizure and for power saving.
 - 1) 120 seconds after steady state display appeared since the main switch (power) was turned on.
 - 2) 30 seconds after normal operation

■ Indicator abnormality and troubleshooting

- There are cases where the display on the indicator becomes abnormal due to noise.

In such a case, turn off the main switch and turn it on again about 5 seconds later.

* However, there is a possibility where reset does not occur if noise is continuing.

Eliminate the cause for the noise, and then turn on the power again. If it is not possible to identify the cause for the noise, please contact your dealer or our office.

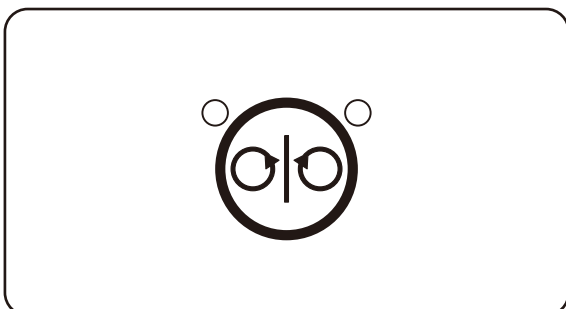
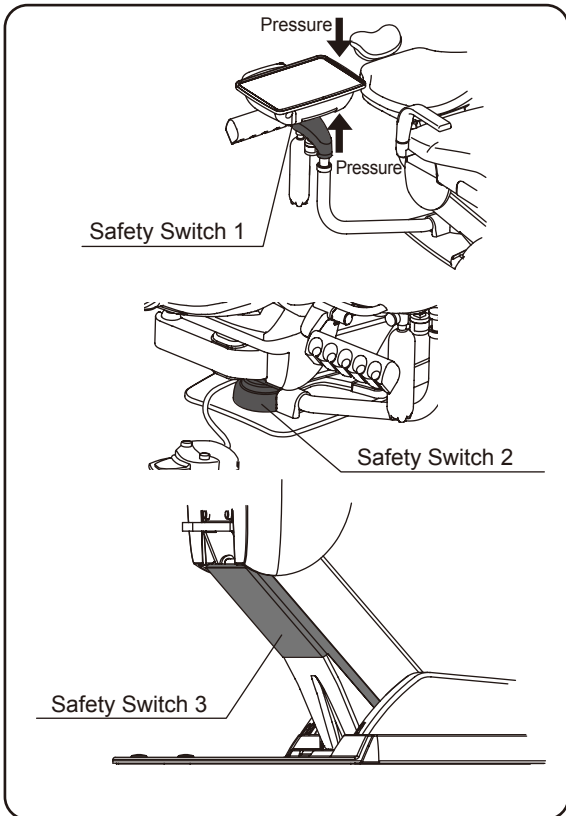
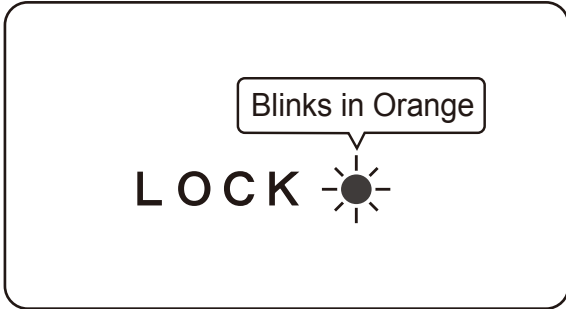
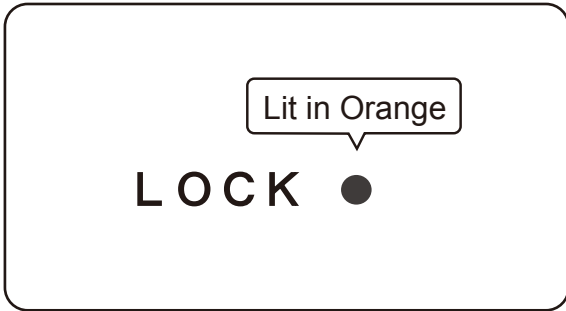

■ Chair motion stop function (safety function)

● The safety mechanism that inhibits chair motion works while any of the following actions is taken. The "LOCK" LED indicator lamp is lit in orange in this state.

- Foot controller is being depressed.
- Setup is in progress with function switch on the doctor control panel.

● The safety mechanism that inhibits chair auto movement (P1, P2, LP, 0) while any of the following actions is taken (safety switch 1.2.3). The "LOCK" LED indicator lamp is blinking in orange in this state.

[Safety switch 1]

If excess pressure (upward or downward) is applied to the doctor table by the movement of chair, safety device stops the chair movement to protect the table from being damaged.

[Safety switch 2]

When the doctor table is turned to the back side of the backrest and chair auto motion of the chair is locked

[Safety switch 3]

When pressure is detected on the surface of lower link cover, the chair automatically stops and moves up slightly for safety.

■ Handpiece rotation stop function

• If a handpiece is picked out of the holder in the state where the foot controller pedal is depressed, the micromotor of this handpiece will not run. The indicator lamp in the micromotor forward/reverse select switch flickers in orange in this state and thus indicates that the safety mechanism is working. Make sure to pick up a handpiece first, and then depress the foot controller for operation.

ADJUSTMENT OF PARTS

1 Junction Box Section

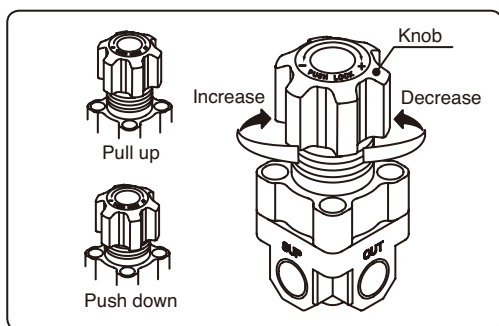

■ Main air pressure reducing valve

- This knob adjusts the main pressure of air supplied to the unit.
- Pull the knob and turn as shown in the drawing so that the main air pressure gauge reads a value between 0.45 and 0.5 MPa.
- Be sure to press the knob to lock it after setting.
- This knob is adjusted when installing the unit. Do not change the setting under normal conditions.

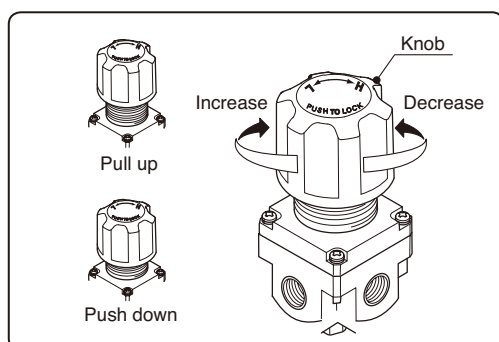

■ Main water pressure reducing valve

- This knob adjusts the main pressure of water supplied to the unit.
- Pull the knob and turn as shown in the drawing so that the main water pressure gauge reads a value between 0.1 and 0.2 MPa.
- Be sure to press the knob to lock it after setting.
- This knob is adjusted when installing the unit. Do not change the setting under normal conditions.

2 Doctor Unit Section

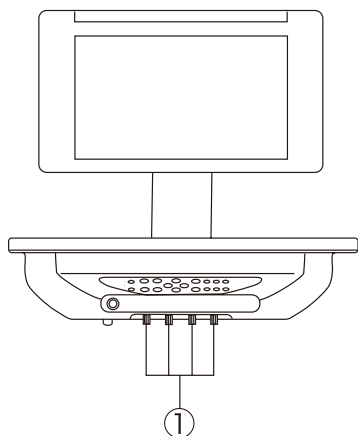

Front side of under the doctor table

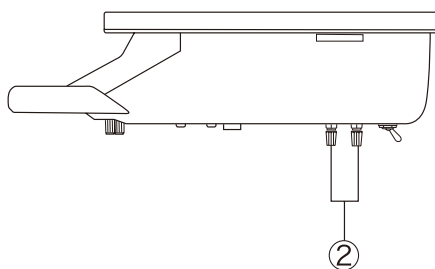

Right side of under the doctor table

■ Water adjustment of the handpiece spray

- The water flow rates of the handpiece of the Doctor's unit may be adjusted with the knob (1)(blue knob).

■ Water/air adjustment of the syringe spray

- The water and air flow rates of the syringe of the Doctor's unit may be adjusted with the knob (2).

Blue capWater

Yellow cap... Air

- * The flow rate is decreased by turning any knob clockwise. It is increased by turning the knob counterclockwise.

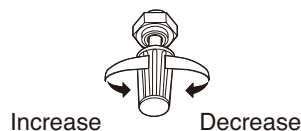

NOTICE

Flow rate adjustment knobs are intended to increase/decrease the flow rate, but do not serve as stop valves. Caution should be exercised as turning the knob excessively may cause it to loosen.

1 Chair Section

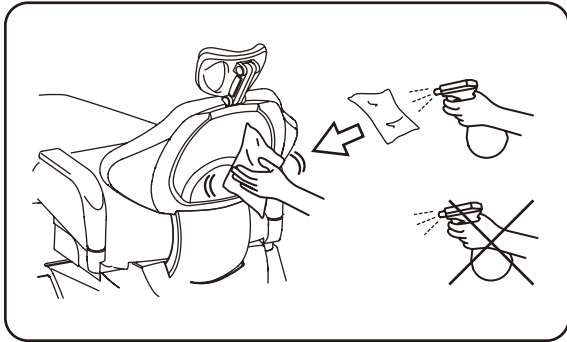

■ Chair Surface Cleaning and Disinfection

- The surface of the chair's seating area is made of synthetic leather. Apply dry wiping, wipe the surface with wet cloth or moistened with a 10% detergent solution diluted using water. In case the synthetic leather is wiped with a wet cloth, fully wipe off the moisture with dry cloth.
- If the color of clothing or belt remained on the synthetic leather, wipe it off with cloth moistened with a 10% detergent solution diluted using water as soon as possible, to avoid penetration caused by plasticizer.
- In case the synthetic leather is wiped with a wet cloth, fully wipe off the moisture. If it remains, hydrolytic degradation may be accelerated. Do not use solvent and bleach.
- Use FD366 made by Durr for cleaning and disinfection of the product exterior.
- Apply dry wiping using a dry and soft cloth to metallic and resin cover areas.

CAUTION

1. If there is stains, wipe clean as quickly as possible with a 10% detergent solution diluted using water to prevent permanent staining and fully wipe off the moisture with dry and soft cloth.
2. Do not place any hard and heavy article or any article having a sharp tip or edge on the chair's seating area. The synthetic leather may be damaged otherwise.
3. For cleaning the resin cover, do not use cleaning agents containing solvent or abrasives, thinners or oil-based alcohol (butanol and isopropyl alcohol), which may cause cracks.
4. If any metallic area is wetted, wipe off the moisture as soon as possible. They may facilitate rust generation.

CARE AND MAINTENANCE

2 Doctor Unit Section

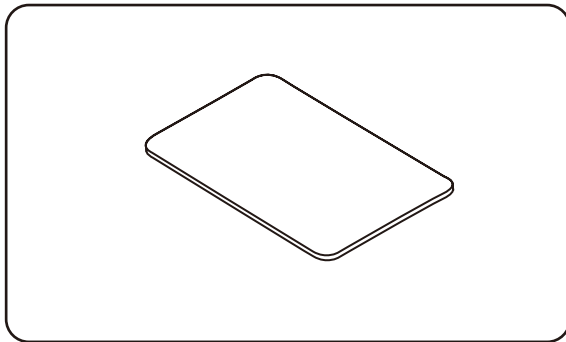
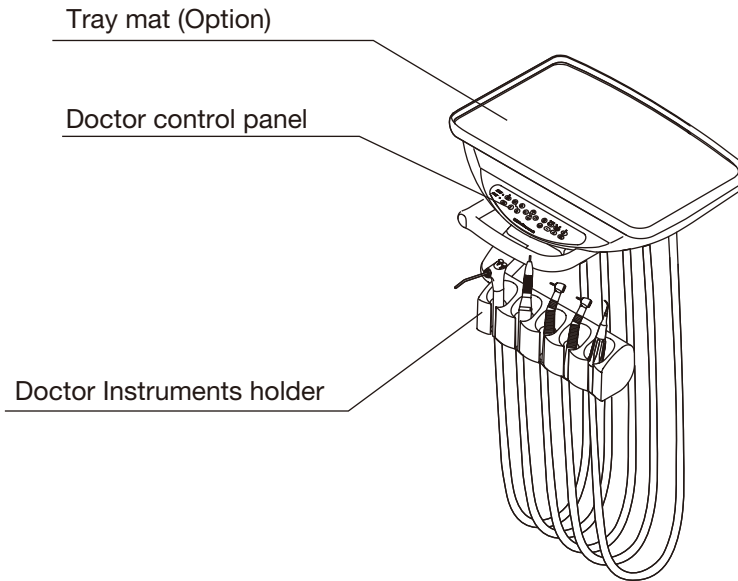

■ Tray mat (Optional)

- The tray mat may be detached and sterilized in an autoclave (for 20 minutes at 121°C or 12 minutes at 132°C). Remove residues and clean carefully with running water before sterilization.
- Be sure to put into a sterilization pouch when sterilizing.
- The tray mat is made of resin and may become deteriorated if it is sterilized in an autoclave many times. The allowable sterilization frequency in an autoclave is 250 times.
- After autoclave sterilization, the tray may be subject to discoloration, which does not have a negative effect on performance.



■ Doctor control panel

- Use FD333 or FD366 made by Durr or ethanol as sprayed to a soft cloth for cleaning and disinfection. Wipe off with dry soft cloth to dried up for the doctor control panel.

! CAUTION

- In case the surface of the doctor control panel is wiped with disinfectant agent or the like, fully wipe away the chemical. Control panel malfunction may arise if the chemical penetrates to the back face of the doctor control panel.
- Do not spray liquids directly onto unit surfaces, holder and operation panel. In order to prevent damage to electrical components and system.

2 Doctor Unit Section



■ Doctor Instrument holder

- Use FD333 or FD366 made by Durr or ethanol as sprayed to a soft cloth for cleaning and disinfection. Wipe off with dry soft cloth to dried up of the instrument holder after cleaning and disinfection.

⚠ CAUTION

Do not spray liquids directly onto unit surfaces, holder and operation panel. In order to prevent damage to electrical components and system.

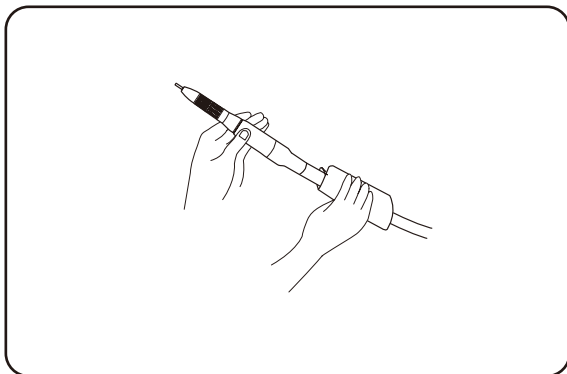

■ Cleaning of Handpiece hose

- Carefully wipe away the filth from the handpiece hose using soft cloth moistened with alcohol or the like.

■ Care and Maintenance of of Handpiece hose

Observe instructions given in handpiece instruction manuals for the care of handpieces.

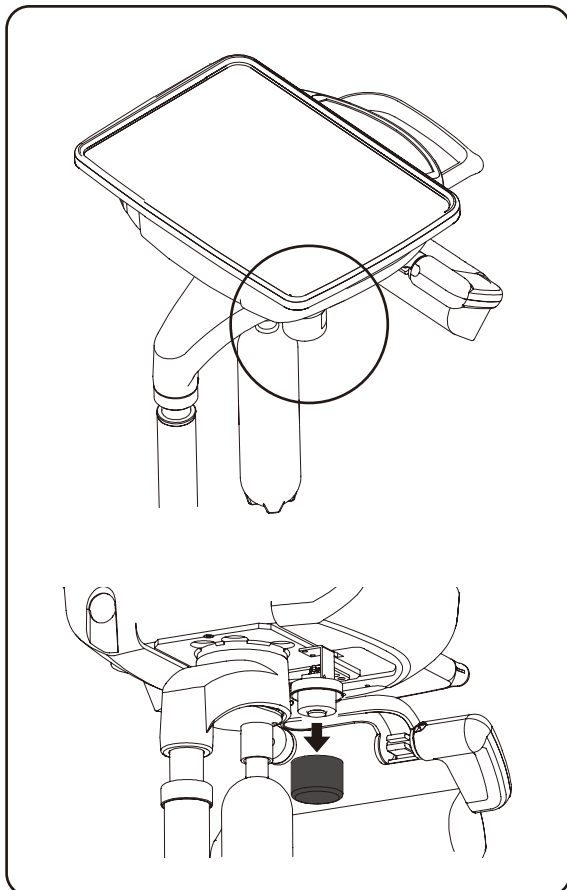

■ Oil mist separator (Optional)

- The oil mist separator collects oil contained in exhaust air from the handpieces.
- Be sure to dispose of oil when oil is collected up to the red line of the oil reservoir.
- The oil reservoir may be detached when it is rotated counterclockwise.

3 Cuspidor Unit Section

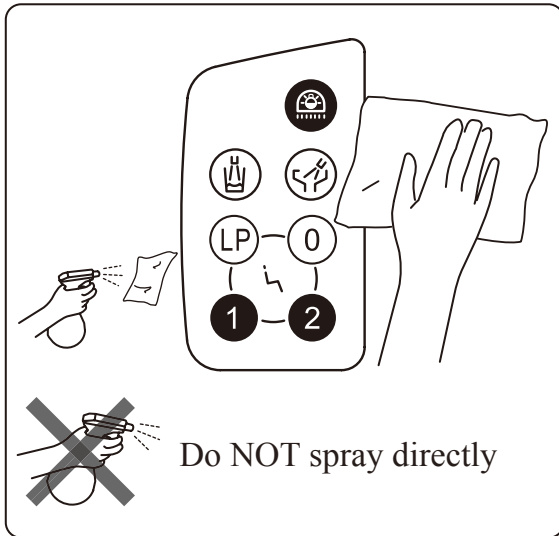

■ Assistant control panel

- Use FD333 or FD366 made by Durr or ethanol as sprayed to a soft cloth for cleaning and disinfection. Wipe off with dry soft cloth to dried up of the assistant control panel.

⚠ CAUTION

- In case the surface of the assistant control panel is wiped with disinfectant agent or the like, fully wipe away the chemical. Control panel malfunction may arise if the chemical penetrates to the back face of the assistant control panel.
- Do not spray liquids directly onto unit surfaces, holder and operation panel. In order to prevent damage to electrical components and system.



■ Assistant Instrument holder

- Use FD333 or FD366 made by Durr or ethanol as sprayed to a soft cloth for cleaning and disinfection. Wipe off with dry soft cloth to dried up of the assistant instrument holder.

⚠ CAUTION

- Do not spray liquids directly onto unit surfaces, holder and operation panel. In order to prevent damage to electrical components and system.

CARE AND MAINTENANCE

3 Cuspidor Unit Section

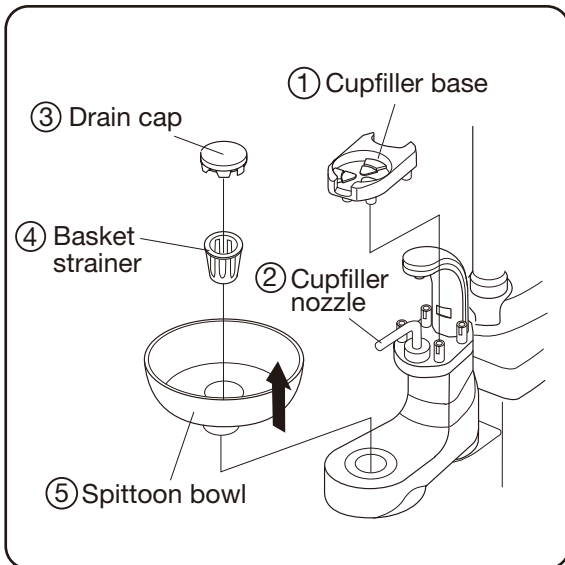

■ Cleaning of spittoon section

• Use MD550 made by Durr to cleaning the spittoon bowl. Detach the spittoon bowl according to the following procedures.

1. Remove the (1) cupfiller base.
2. Swing the cupfiller nozzle to outward.
3. Remove the (3) drain cap and pull out the (4) basket strainer.
4. Pull out the spittoon bowl .

Place the all parts in a reverse procedure after cleaning.

- Wash the cupfiller base, drain cap and basket strainer with running water
- The basket strainer in the spittoon bowl is easily clogged. Clean it at the end of each work day.

! CAUTION

- Turn off the main switch when cleaning the spittoon bowl or cup filler tray. Otherwise, response to hands or objects during cleaning may produce discharge of water, including bowl rinse water, leading to rusting of metals.
- The spittoon bowl is made of glass. It may break if it is impacted. Do not wash it with hot water. Otherwise, it may break.
- Never use sandpaper, metal scrub brushes and abrasive cleaning agents to clean the bowl.
- Do not use strongly acidic cleaning agents or alkaline pipe cleaning agents, which may cause corrosion of metals, etc.

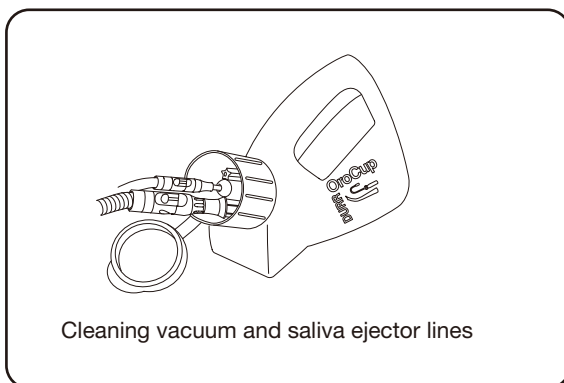

Cleaning vacuum and saliva ejector lines

■ Cleaning of vacuum / saliva ejector lines

The sucking unit comes into contact with secretions, spit and blood that contain bacteria every day. Be sure to clean and sterilize it at the end of each work day.

Recommended cleaner : Ortol Plus made by DURR.

! CAUTION

Do not use strongly acidic cleaning agents or alkaline pipe cleaning agents, which may cause corrosion of metals, etc/

3 Cuspidor Unit Section

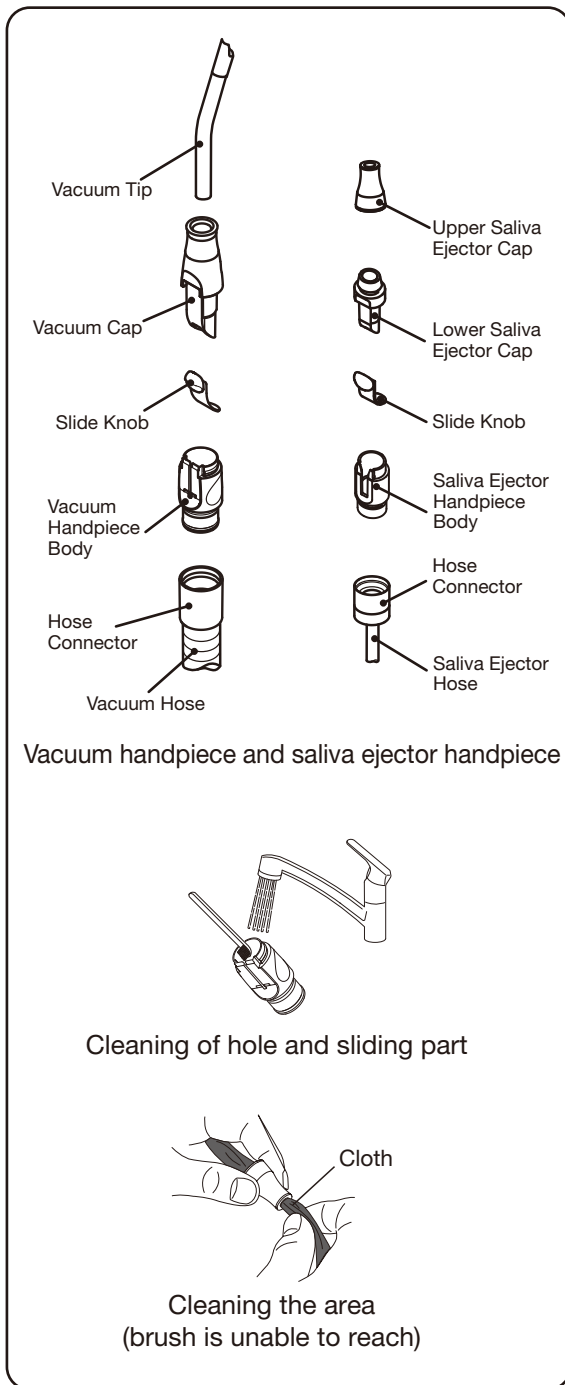

■ Cleaning of Vacuum Handpiece / Saliva Ejector Handpiece

• For effective sterilization, washing for removing contamination and immersion by a cleaning agent are required. Then, rinse by water in order to remove residual cleaning agent on medical device.

Take following procedures from cleaning to sterilization.

* Use the disposable saliva ejector tip.

[Disassembly]

Disassemble the handpiece for the preparation of cleaning as the following figures show.

Pull the hose connector to disconnect the vacuum hose.

[Cleaning by hand]

1. Wipe off the surface contamination by a cloth while rinsing the surface by running clean warm water at 40 ± 5 degrees. Scrub the intubation or hole, slide groove and filter by a cleaning brush or by a tooth brush with running clean warm water at 40 ± 5 degrees. Wipe off by a cloth for the area which brush is unable to reach.
2. Check whether contamination is removed or not after cleaning. Continue the cleaning if contamination is remained.
3. Immersed with an alkaline disinfection or detergent for 5 minutes.
(We recommend to use ID212 made by DURR)
4. Rinse thoroughly by distilled water at ordinary temperature or by clean water for more than 1 minute.

⚠ CAUTION

- Cleaning must be done within 1 hour after use.
Replace with a new vacuum handpiece and saliva ejector handpiece for following cases.
- Any waste material can not be removed by clogged hole.
- Contamination and solid material attached to vacuum handpiece and saliva ejector can not be removed.

3 Cuspidor Unit Section

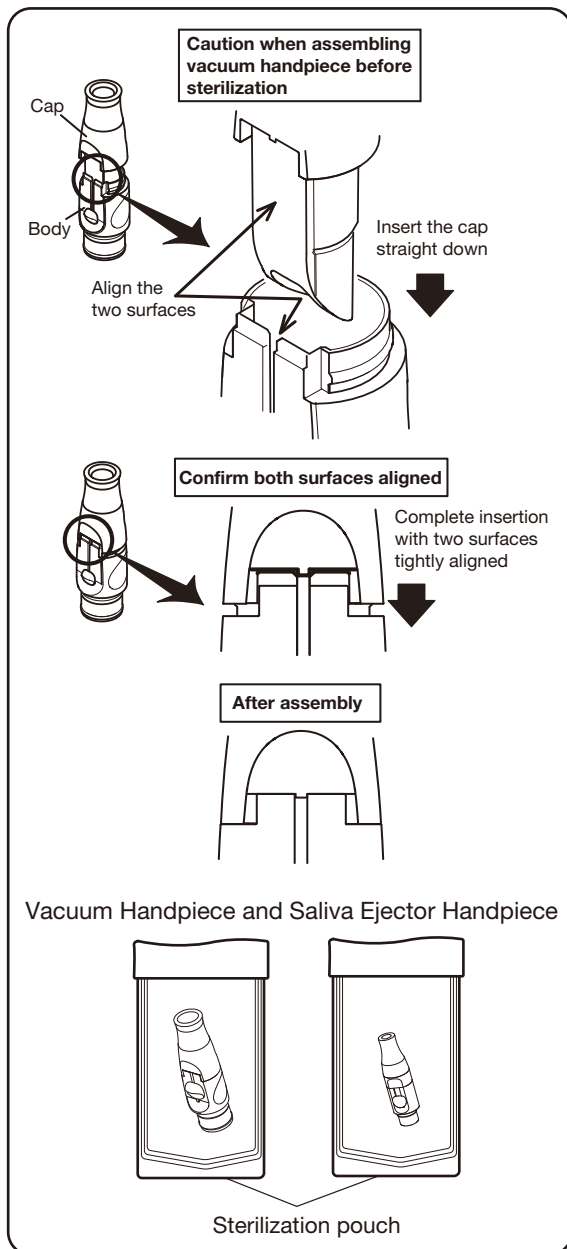

■ Sterilization of vacuum / saliva ejector handpiece

Sterilization must be done every after use to patients. Vacuum Tip/Vacuum Cap/ Vacuum Handpiece Body/Saliva Ejector Handpiece Body can be autoclave. Vacuum handpiece body and saliva ejector body have to assemble before autoclave.

When assembling the vacuum handpiece, align the two surfaces; a flat surface of the cap and the surface of the sliding groove of the body. Then, slide the cap into the body straight.

* **Do not insert it twisted.**

- A. Insert the handpiece in a sterilization pouch and seal it.
- B. Autoclave for 3 min. at 134°C and dry for 15 min.

Sterilization with autoclave is permitted up to 250 times. However, sterilization of the slide knob with autoclave is permitted up to 100 times (because of application of load at the time of sliding).

Storage

After sterilizing the handpiece, keep it in the sterilization pouch and store in a dark and cool place.

! CAUTION

- Sterilization by class B cycles.
- Sterilization temperature is 135 °C or less.
- The cap, filter and body are made of resin. They may become deteriorated if they are sterilized in an autoclave many times.
- After autoclave sterilization, the cap, filter, body and valve are subject to discoloration, which does not have a negative effect on performance.
- The slide knob can be autoclave 100 times and is expendable supplies.
- Dry naturally if the temperature for drying process is to exceed 135°C.
- If damage occurs to the sterilization pouch, discard and sterilize again using a new pouch.

3 Cuspidor Unit Section

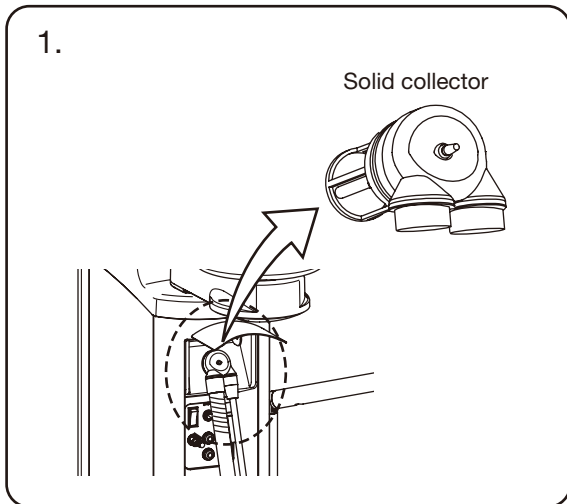

■ Cleaning of the solid collector

Detach and wash the filter in the solid collector of the Cuspidor unit at the end of each work day. If sucked substances are collected, the suction force of the vacuum is reduced.

1. Pull out and detach the filter in the solid collector from cuspidor unit.

2. The filter can be removed from solid collector by pushing the bar from front side of the solid collector and clean with running water.

* The filter is expendable supplies. If damage occurs to the filter, replace with new filter.

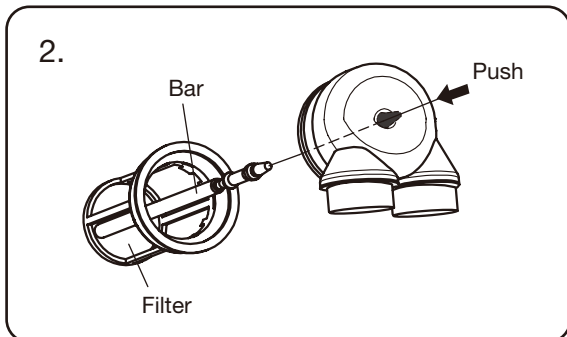

! CAUTION

Clean the filter carefully with running water.
Do not use brush to clean the filter, it may cause damage to the filter.

! CAUTION

After daily operation, run two cup of clean water through handpieces to clean inside.

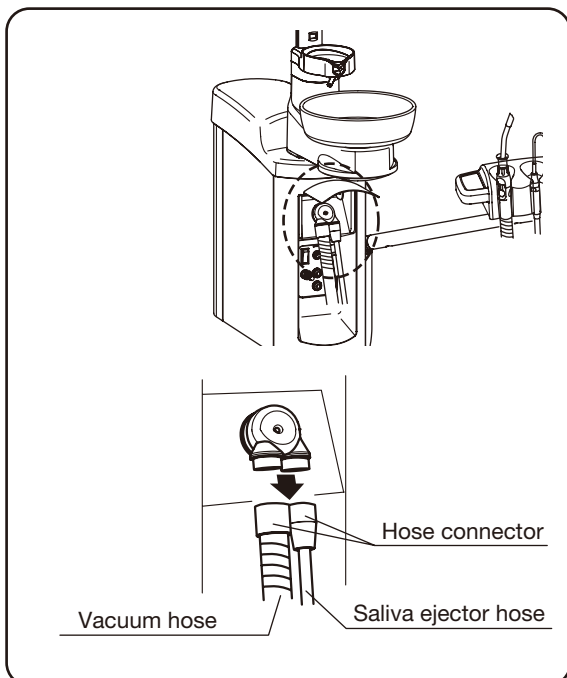

■ Cleaning of vacuum hose / saliva ejector hose

The vacuum hose and saliva ejector hose may be disconnected by pulling them down. They may be cleaned in running water.

(Figure shows standard package, vacuum package do as well)

3 Cuspidor Unit Section

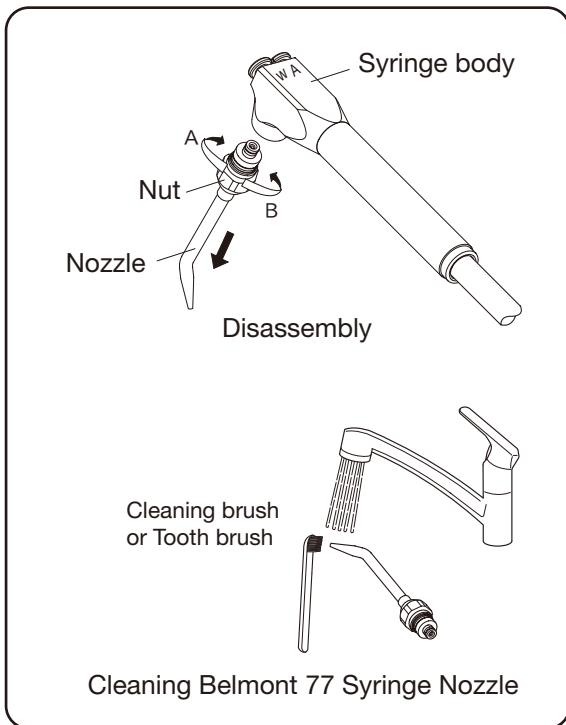

■ Cleaning of Belmont 77 syringe

[Disassembly]

Remove the nozzle from syringe by turning it in direction A.

[Cleaning by hand]

1. Wipe off the surface contamination by a cloth while rinsing the surface by running clean warm water at 40 ± 5 °C. Scrub the tip and joint part of nozzle by a cleaning brush or by a tooth brush with running clean warm water at 40 ± 5 °C.
2. Check whether contamination is removed or not after cleaning. Continue the cleaning if contamination is remained.
3. Immersed with an alkaline disinfection or detergent for 5 minutes. (We recommend to use ID212 made by Durr)
4. Rinse thoroughly by distilled water at ordinary temperature or by clean water for more than 1 minute.

! CAUTION

Cleaning must be done every after use to patients.

Cleaning must be done within 1 hour after use. Replace with a new syringe nozzle if contamination and solid material attached to syringe nozzle can not be removed.

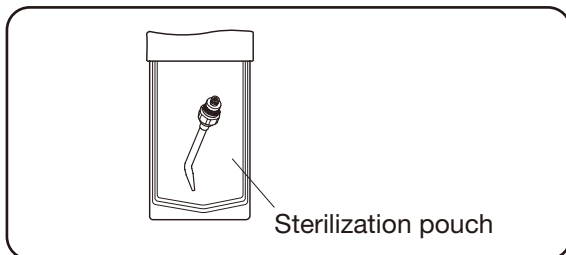

■ Sterilization of Belmont 77 syringe

The nozzle can be sterilized with autoclave. Sterilization with autoclave is permitted up to 250 times.

A. Insert the handpiece in a sterilization pouch and seal it.

B. Autoclave for 3 min. at 134°C and dry for 15 min.

Apply Vaseline thinly and evenly to the two O-rings after sterilization. Tighten the nut firmly in direction B to undo the nozzle.

Storage

After sterilizing the nozzle, keep it in the sterilization pouch and store in a dark and cool place.

! CAUTION

- Sterilization must be done every after use to patients.
- Sterilization by class B cycles.
- Sterilization temperature is 135°C or less.
- Dry naturally if the temperature for drying process is to exceed 135°C .
- If damage occurs to the sterilization pouch, discard and sterilize again using a new pouch.
- Before use, make sure that the nut is firmly tightened.

4 Junction Box Section

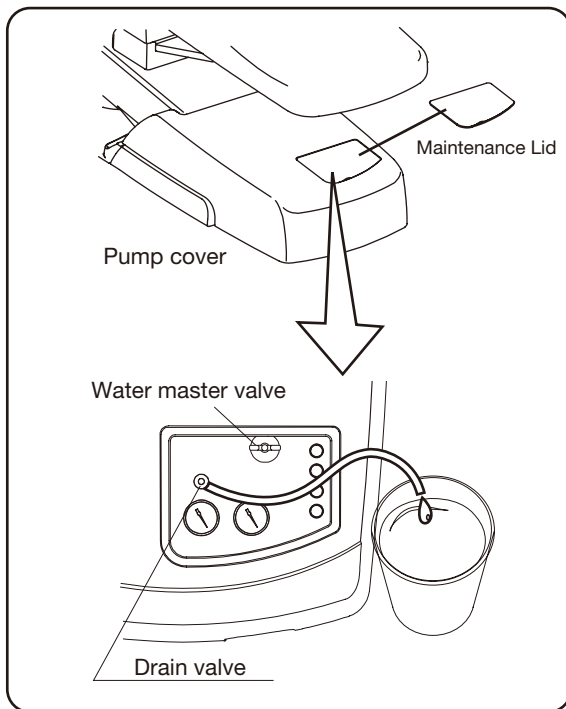

■ Cleaning air filter drain valve and discharging water from air compressor

- Drain valve is used to discharge water from the air filter.
- Turn the drain valve counterclockwise to discharge water collected in the air filter once a week at least.
- If water enters the unit, the air turbine, air motor or syringe, etc., may become defective. Be sure to turn the drain valve clockwise to close the valve after discharging water from the air filter.
- Open the drain valve of the air compressor to discharge collected water once a week.
- It is recommend that the compressor with air dryer or auto drain function for use.
- Turn OFF the main water valve after daily operation and for long term intervals.

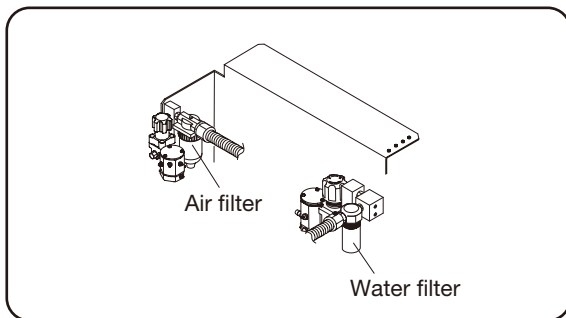

• Filter Replacement

The water filter in the junction box needs to be replaced at least once a year.

The air filter in the junction box needs to be replaced at least once every three years. Contact your local service representative for replacement.

5 Product Exterior

■ Cleaning and disinfection of product exterior

- Use FD333 or FD366 made by Durr or ethanol for cleaning and disinfection of the product exterior.
- Clean the metallic parts and resin parts with a wet soft cloth.

! CAUTION

- If there is stains, wipe clean as quickly as possible with a 10% detergent solution diluted using water to prevent permanent staining and fully wipe off the moisture with dry and soft cloth.
- For cleaning the resin cover, do not use cleaning agents containing solvent or abrasives, thinners or oil-based alcohol (butanol and isopropyl alcohol), which may cause cracks.
- Wipe off water and residual disinfectant immediately. This could cause corrosion, damage or incorrect operation of the unit.

■ Storage method

Strictly observe the following points when the product will not be used for a long period of time (following the completion of work, during the suspension of business, etc.).

1. Main switch

- Be sure to turn off the main switch at the end of each work day . (To stop supply of air, water, electric power, etc.)
- Strictly observe this instruction to prevent water leakage and electric accidents.

2. Water main valve

- Be sure to turn the main water valve counterclockwise to the Close position at the end of each work day.

3. Be sure to turn off the compressor breaker and then discharge air from the compressor. (Be sure to turn off the power.)

4. Be sure to turn off the vacuum pump breaker. (Be sure to turn off the power.)

5. Be sure to turn off the equipment breaker on the clinic's electrical panel. (Be sure to turn off the power.)

■ Lifetime

The durable period of this product is 10 years (self-certification based on in-house data), provided regular maintenance and inspection is done. However, parts requiring periodical maintenance have different durability periods. See the section on maintenance and inspection.

■ Consumable parts

The consumable parts are predicted to be abrasion, deterioration, and changes in external appearance or damage through use. Please note that repair or replacement of these parts is not covered by warranty, and fees will be required.

The level and period of abrasion, deterioration or damage may differ depending on the environment and condition that the client uses this product in)

■ Stock period of parts

Our company will keep maintenance parts of the products such as consumables and periodical replacement parts, etc., for ten years after sales.

Note : Maintenance parts means parts necessary for repair services for restoring the original conditions and functions of the product and maintaining those functions.

■ Disposing of equipment

When disposing the unit & chair, appropriately dispose complying with all current applicable regulations and local codes. In EU area, EU directive 2002/96/EC on waste electrical and electronic equipment (WEEE) is applied on this product. In this directive, environment conscious recycling/abandonment is obligated.

BEFORE ASKING FOR REPAIRS

If any of phenomena described below has occurred, make the following checks before asking for repairs.

Phenomenon	Check point and result	Action to be taken
The product does not work at all.	Main switch is not on.	Turn on the main switch.
	Air compressor power is not on.	Turn on the power.
	Equipment circuit breaker in the clinic cabinet panel is not on.	Turn on the equipment circuit breaker.
The chair does not work.	Locking device for motion stop is activated.	Unlock the device. See page 51.
Water is not supplied.	Water main valve is closed.	Open the water main valve.
	Water quantity adjust valve or knob of handpiece, etc., is closed.	Open valve or knob.
No water is fed to cup. (Sensor cupfiller type)	Cup other than specified cup is used.	Use white or pale-color paper cup and weight 5 oz or less for dental use.
	Paper cup is wetted.	Replace paper cup.
	Cupfiller sensor is wet.	Wipe off and clean the surface of sensor cupfiller.
Water overflows from cup. (Sensor cupfiller type)	Cup other than specified cup is used.	Use white or pale-color paper cup and weight 5 oz or less for dental use.
	Paper cup is crushed (bend out of shape)	Replace paper cup.
	Cupfiller sensor is wet.	Wipe off and clean the surface of sensor cupfiller.
Vacuum suction is not executed.	Power of the vacuum pump has not been turned on.	Turn on the power.
	Solid collector filter is contaminated.	Clean the filter.
	Vacuum handpiece filter is contaminated.	Clean the filter.
Saliva ejector does not suck.	Saliva ejector filter is contaminated.	Clean the filter.

If the unit does not normally work even if actions were taken upon checkup stated above, then stop using the unit, turn off the main switch and contact your dealer or our office.

DIMENSIONS AND SPECIFICATIONS

Standard Package (Chair + Doctor Unit + Cuspidor Unit)

- Rated power supply : 230 VAC, 50/60 Hz, 3.5/3.5A
- Fuse : 5A/250V(Current Rating:50A at 250VAC) Fast blow
Size of Fuse (5 x 20mm)
- Weight : 185kg
- Maximum Load : Patient capacity 135kg
- Load capacity : Doctor table 3kg
- Classification of foot controller : IPX1(applicable standard IEC60529)
- Protection class against electric shock : Class I equipment
- Applied part : type B applied part

Seat for chair

Handpieces for unit (List of compatible handpieces)

- Usage environment : Temperature 0 to 40°C
Humidity 10 to 95 %
Air pressure 700 to 1060 hPa
- Transportation / Storage environment : Temperature -20 to +70°C
Humidity 10 to 95 %
Air pressure 700 to 1060 hPa
- Mode of operation : Non-Continuous Operation
Duration of Maximum Operating Time:3min, Duty 1:5

Dimensions

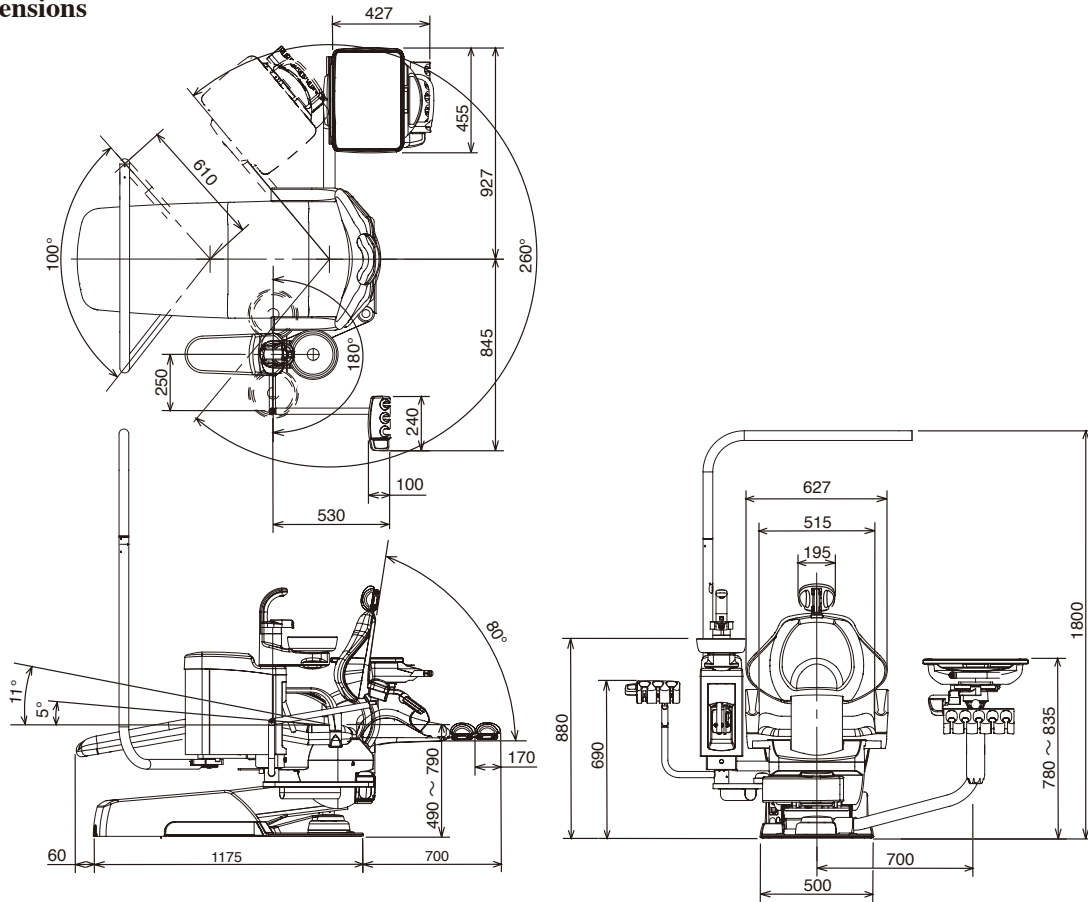

* Values are the standard values. (Unit: mm)
Dimensional tolerance: ±10%

DIMENSIONS AND SPECIFICATIONS

Doctor Package (Chair + Doctor Unit)

- Rated power supply : 230 VAC, 50/60 Hz, 3.5/3.5A
- Fuse : 5A/250V(Current Rating:50A at 250VAC) Fast blow
Size of Fuse (5 x 20mm)
- Weight : 155kg
- Maximum Load : Patient capacity 135kg
- Load capacity : Doctor table 3kg
- Classification of foot controller : IPX1(applicable standard IEC60529)
- Protection class against electric shock : Class I equipment
- Applied part : type B applied part
Seat for chair
Handpieces for unit (List of compatible handpieces)
- Usage environment : Temperature 0 to 40°C
Humidity 10 to 95%
Air pressure 700 to 1060 hPa
- Transportation / Storage environment : Temperature -20 to +70°C
Humidity 10 to 95%
Air pressure 700 to 1060 hPa
- Mode of operation : Non-Continuous Operation
Duration of Maximum Operating Time:3min, Duty 1:5

Dimensions

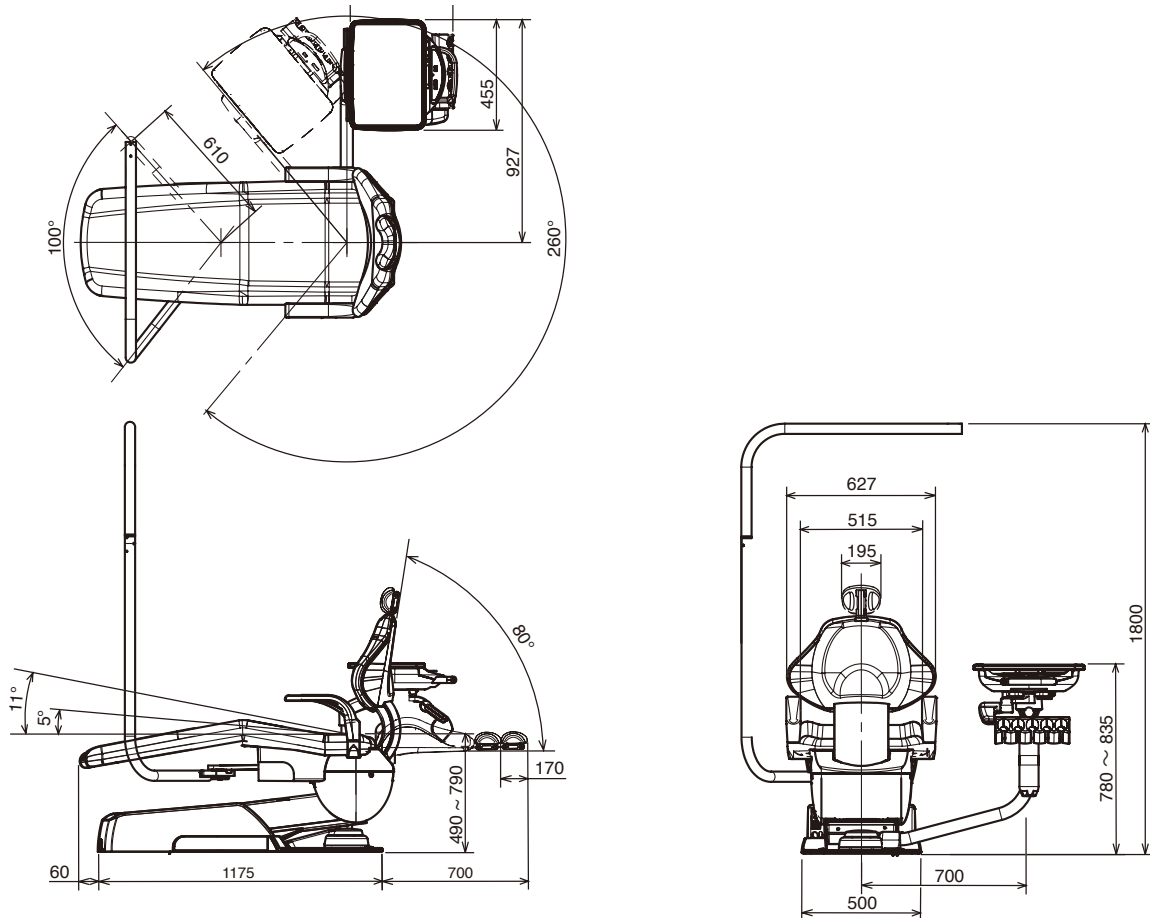

* Values are the standard values. (Unit: mm)
Dimensional tolerance: ±10%

DIMENSIONS AND SPECIFICATIONS

Cuspidor Package (Chair + Cuspidor Unit)

- Rated power supply : 230 VAC, 50/60 Hz, 3.5/3.5A
- Fuse : 5A/250V(Current Rating:50A at 250VAC) Fast blow
Size of Fuse (5 x 20mm)
- Weight : 160kg
- Maximum Load : Patient capacity 135kg
- Classification of foot controller : IPX1(applicable standard IEC60529)
- Protection class against electric shock : Class I equipment
- Applied part : type B applied part
Seat for chair
Handpieces for unit (List of compatible handpieces)
- Usage environment : Temperature 0 to 40°C
Humidity 10 to 95%
Air pressure 700 to 1060 hPa
- Transportation / Storage environment : Temperature -20 to +70°C
Humidity 10 to 95%
Air pressure 700 to 1060 hPa
- Mode of operation : Non-Continuous Operation
Duration of Maximum Operating Time:3min, Duty 1:5

Dimensions

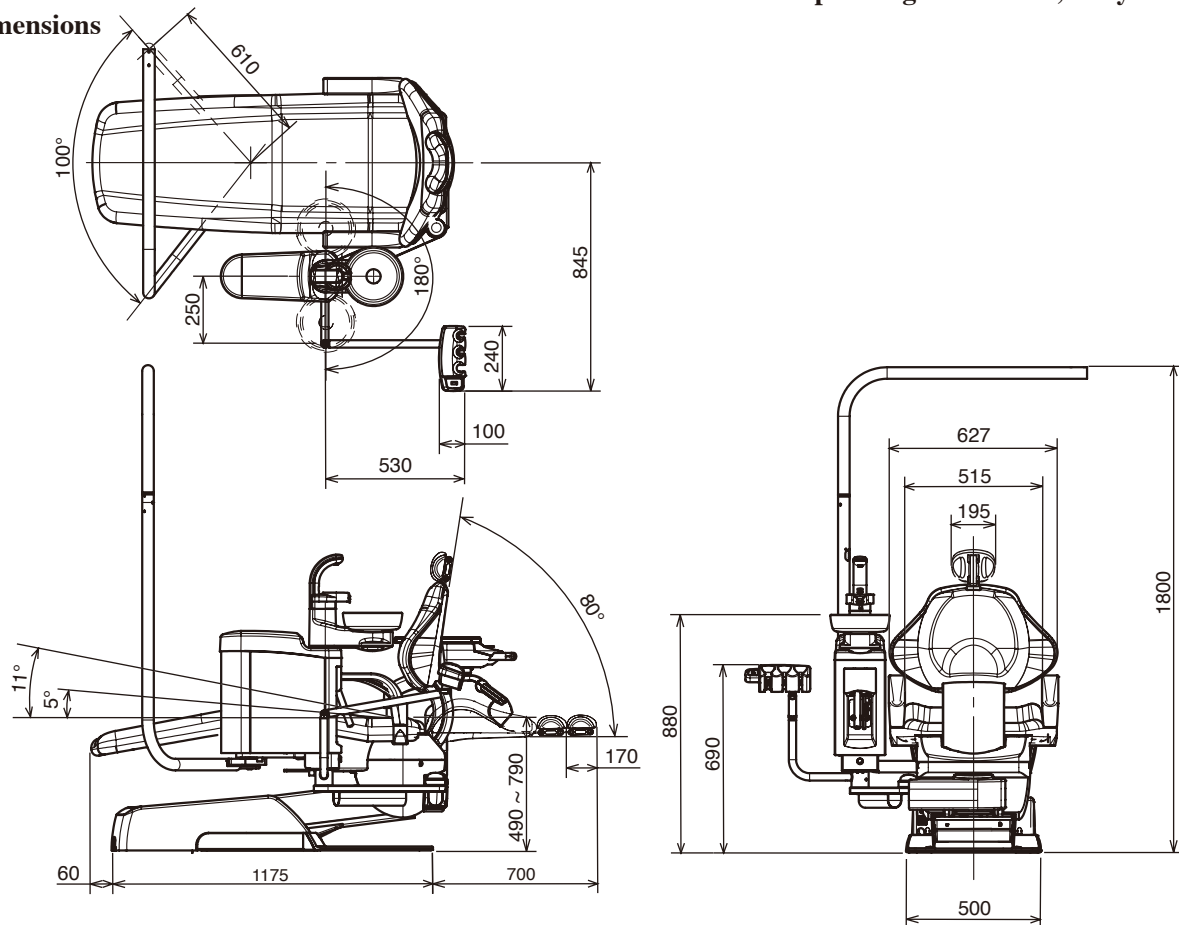

* Values are the standard values. (Unit: mm)
Dimensional tolerance: ±10%

DIMENSIONS AND SPECIFICATIONS

Vacuum Package (Chair + Doctor Unit + Vac Pac)

- Rated power supply : 230 VAC, 50/60 Hz, 3.5/3.5A
- Fuse : 5A/250V(Current Rating:50A at 250VAC) Fast blow
Size of Fuse (5 x 20mm)
- Weight : 170kg
- Maximum Load : Patient capacity 135kg
- Load capacity : Doctor table 3kg
- Classification of foot controller : IPX1(applicable standard IEC60529)
- Protection class against electric shock : Class I equipment
- Applied part : type B applied part

Seat for chair

Handpieces for unit (List of compatible handpieces)

- Usage environment : Temperature 0 to 40°C
Humidity 10 to 95%
Air pressure 700 to 1060 hPa
- Transportation / Storage environment : Temperature -20 to +70°C
Humidity 10 to 95%
Air pressure 700 to 1060 hPa
- Mode of operation : Non-Continuous Operation
Duration of Maximum Operating Time:3min, Duty 1:5

Dimensions

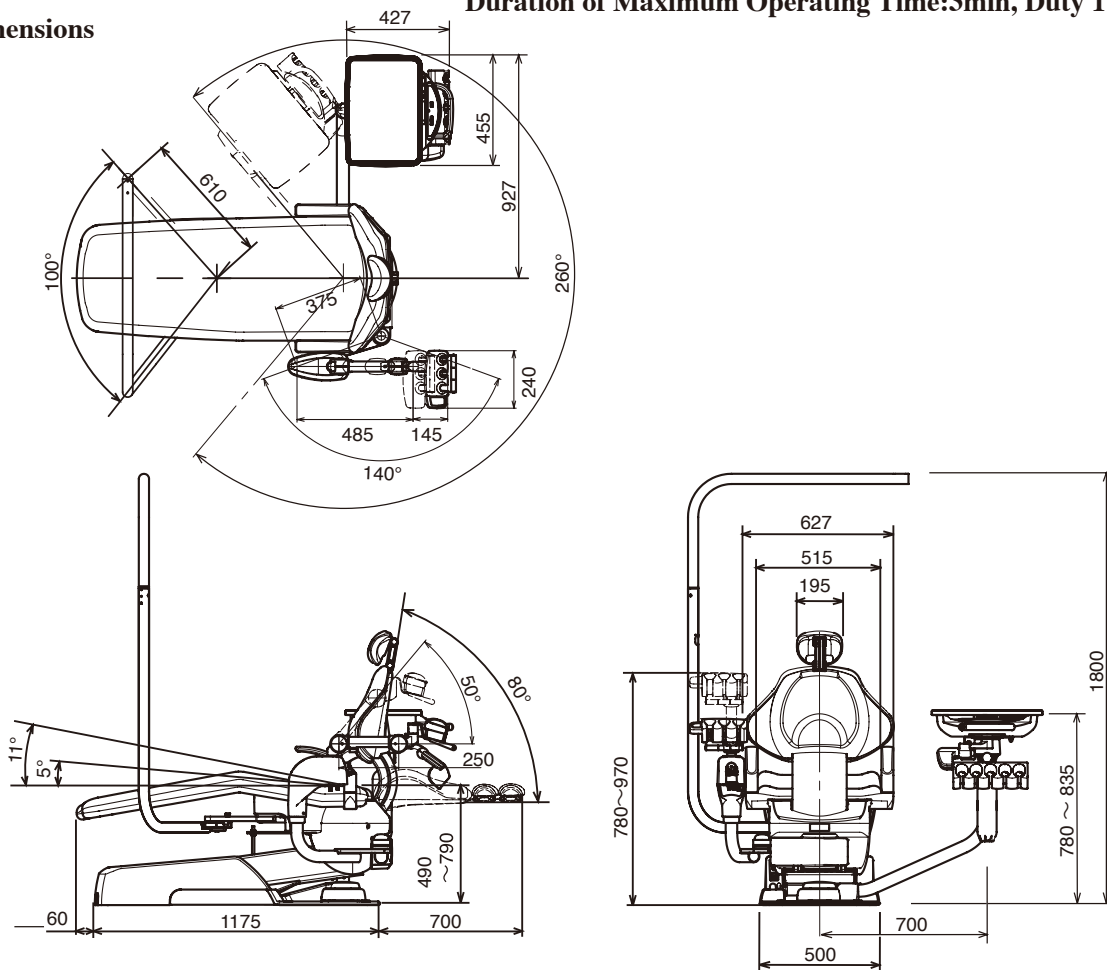

* Values are the standard values. (Unit: mm)
Dimensional tolerance: ±10%

MAINTENANCE AND INSPECTION

Guide for daily maintenance and inspection (Maintenance and inspection by user)

- Management of maintenance and inspection of medical equipment should be implemented by the user (medical institution). In case the user does not implement such management, it is permitted that such management is outsourced to a qualified entity such as a medical equipment repair company.
- For safe use of this product, it is necessary that inspection should be conducted in the specified frequency on the items described below.

No.	Item	Frequency	Inspection method and diagnosis	Influence if inspection not conducted	Maintenance required in case of nonconformity
1	Check of safety functions	Before start	Make sure the chair movement stops when pressed switched as showing on page_21 during chair auto movement.	Unexpected personal injury and troubles may arise due to motion of the chair during medical treatment and due to pinching between doctor section and chair.	Contact your dealer or our office if any abnormality arises.
2	Check for leakage of water, air and oil.	Before start	Leakage of water,air and oil shall not be observed around the product.	The product will not normally work, and troubles may arise.	Contact your dealer or our office if any abnormality arises.
3	Sensor Cupfiller (option)	Before start	When a paper cup is placed on the cupfiller, the cup shall be detected and cupfilling shall be executed. * Malfunction may arise if the cup is of another material grade (such as stainless steel and plastics) or if the paper cup is of dark color or pattern.	Cupfilling may not be executed.	Execute re-inspection in accordance with "Method for operation" described in the instruction manual. Contact your dealer or our office if recovery is not achieved as a result of re-inspection.
4	Check of motions of equipment	Before start	①Air turbine revolution, water flow, air flow and so forth shall be free of abnormality. ②Micromotor revolution, water flow and so forth shall be free of abnormality. ③Scaler vibration, water flow and so forth shall be free of abnormality.	Troubles such as injury in patient's oral cavity and equipment failure may arise.	Control the water flow in accordance with "Control of components" described in the instruction manual. If any other abnormality arises, refer to the instruction manual attached to individual equipment. Contact your dealer or our office if recovery is not achieved.
5	Check of flushout operation	Before start / After closing	To surely perform a flushout by referencing page 10 for procedure of flush out.	The risk of bacteria reproduce.	Contact your dealer or our office if any abnormality arises.
6	Check of air turbine bar	For each patient	Appropriate bar shall be positively mounted. Make sure to refer to the instruction manual attached to individual equipment.	The bar will not normally work and troubles may arise.	If abnormality such as flaw and deformation is found on the bar, replace the bar in accordance with the instruction manual attached to individual equipment.
7	Check of scaler tip	For each patient	Appropriate tip shall be positively mounted and be correctly used. Make sure to refer to the instruction manual attached to the scaler.	The tip will not normally work and troubles may arise.	If the tip was worn or deformed, replace the tip in accordance with the instruction manual attached to the scaler. Contact your dealer or our office if any other trouble arises.
8	Check of tightness of syringe nut	For each patient	The nut for fixing the nut of Type 77, 3-way syringe shall be positively tightened.	Troubles may arise if the nut comes off.	Turn and positively retighten the nut that fixes the nozzle.

MAINTENANCE AND INSPECTION

No.	Item	Frequency	Inspection method and diagnosis	Influence if inspection not conducted	Maintenance required in case of nonconformity
9	Matters attached to micromotor	After closing	Excessive handpiece oil or the like shall not be attached to the motor section.	The motor section will not work normally and troubles may arise.	Execute care in accordance with the instruction manual attached to individual micromotor.
10	Care Vacuum and saliva ejector handpiece	After closing	Flush the suction line, and then clean the filter of the vacuum or saliva ejector handpiece.	Faulty suction may arise.	Clean the suction line and filter in accordance with "Method for care" described in the instruction manual.
11	Care Cuspidor section	After closing	Clean the cuspidor and dust filter.	Faulty water drainage may arise.	Execute dust removal and cleaning in accordance with "Method for care" described in the instruction manual.
12	Care Solid collector	After closing	Clean the filter of the solid collector.	Vacuum suction will become weak.	Clean the filter in accordance with "Method for care" described in the instruction manual.
13	Care Exterior	After closing	Chemical, filthy water and so forth shall not be found (attached or remaining) on the product exterior.	Discoloration and deterioration to the exterior, and corrosion and rusting to metallic components may arise.	Execute wiping in accordance with "Method for care" described in the instruction manual.
14	Check of main switch and main valves	After closing	The product main switch shall be off, and water/air main valves shall be closed.	Product failure and troubles may arise.	Contact your dealer or our office if the main switch cannot be turned off or if the main valve cannot be closed.
15	Product's moving parts	Once every week	No abnormal noise or the like shall be produced from product's moving parts when the product is operated.	The product will not normally work and troubles may arise.	Contact your dealer or our office if any abnormality arises.
16	Care Drain valve	Once every week	Water may enter the air line, and equipment failure may arise.	Drain the water from the air filter drain valve.	Drain the water from the air filter in accordance with "Method for care" described in the instruction manual.
17	Check of water pressure and air pressure	Once every month	Check the water pressure and air pressure by reading pressure gauges in the U-Box section. Basic set pressure : Water: 0.1 to 0.2 MPa Air: 0.45 to 0.5 MPa	The product will not normally work, and troubles may arise.	Contact your dealer or our office if the set pressure is abnormally high or low.
18	Check of conditions of table section	Once every month	The table shall be free of inclination, and water shall not flow on the table.	Injury caused by falling of goods located on the table and other troubles may arise.	Contact your dealer or our office if any abnormality arises.
19	Care Oil mist separator	Once every month	The oil level in the oil mist separator shall be lower than the red line.	Normal output will not be produced due to inferior handpiece exhaust.	Discharge the oil in accordance with "Method for care" described in the instruction manual.

MAINTENANCE AND INSPECTION

Guide for Periodical Check-up

- Some parts and components of the products are degraded or deteriorated depending on the frequency of use.
Annual check-up and maintenance, as well as replacement of consumable parts, are required.
- The required parts (including consumable parts) are listed below. It may be different from the following list depending on the option of the unit.
- For check-up and repair, call a technician of our authorized dealer.

Parts and components that require periodical check-up

No.	Parts Description	Standard Lifetime	No.	Parts Description	Standard Lifetime
1	Vacuum handpiece body	3 years	8	Regulator	3 years
2	Saliva ejector handpiece body	3 years	9	Valves	3 years
3	Foot controller	5 years	10	Switches	5 years
4	Water supply hose	3 years	11	Film viewer body part	5 years
5	Drain hose	3 years	12	Pressure gauge	3 years
6	Air supply hose	3 years	13	Arm section of moving part	7 years
7	Electric wiring of moving part	5 years	14	Control PCBs.	5 years

Consumable parts

No.	Parts Description	No.	Parts Description
1	Valve for vacuum handpiece body	6	Saliva ejector hose
2	Vacuum tip	7	Filter for oil mist separator
3	Saliva ejector nozzle	8	Filter (Air & Water)
4	Handpiece tubings	9	Bulbs
5	Vacuum hose	10	O-ring, Packing, Diaphragm

CAUTION

Execute the maintenance in accordance with this instruction manual and operating manual attached to each individual equipment (Dental light, Handpiece, etc..).

Failure to maintain this product may lead to physical injury or property damage.

LIST OF COMPATIBLE HANDPIECES

Turbine	Air motor	Micromotor	Scaler	Syringe
NSK Ti-Max X	BIEN AIR Aquilon 830/ UNIFIX/w/Light /PM1132	BIEN AIR MX2	NSK VARIOS170	BTK 77 TYPE
NSK MACH-LITE XT	NSK EX-203/EX-6	BIEN AIR DMCX+MCX	NEWTRON LED/ SP4055 NEWTRON Module + LED Drive Board	FARO 3WAY
NSK PANA-MAX		NSK NLX plus		LUZZANI 3WAY
BIEN AIR BORA S36L/ UNIFIX/w/Light		NSK NLX nano		LUZZANI 6WAY
				DCI 3WAY

ELECTROMAGNETIC COMPATIBILITY (EMC)

ELECTROMAGNETIC COMPATIBILITY(EMC)

This product complies with EMC Standard EN60601-1-2:2015.

1. Precautions regarding EMC and compliance with accompanying documents

Medical electrical equipment requires special precautions regarding EMC and needs to be installed and put into service according to the EMC information provided in this booklet.

2. Effects of RF communication devices

Portable and mobile RF communication devices can affect medical electrical equipment.

3. Installation exclusion environment

Hospitals except for near active HF SURGICAL EQUIPMENT and the RF shielded room of an ME SYSTEM for magnetic resonance imaging, where the intensity of EM DISTURBANCES is high.

4. Electromagnetic emission declaration

Guidance and manufacturer's declaration – electromagnetic emissions		
The tbCOMPASS is intended for use in the electromagnetic environment specified below. The customer or user of the tbCOMPASS should ensure that it is used in such an environment.		
Emissions test	Compliance	Electromagnetic environment - guidance
RF emissions CISPR 11	Group 1	The tbCOMPASS only uses RF energy for its internal function. Therefore, its RF emissions are very low and are not likely to cause any interference with nearby electronic equipment.
RF emissions CISPR 11	Class B	The tbCOMPASS is suitable for use in all establishments, including domestic establishments and those directly connected to the public low-voltage power supply network that supplies buildings used for domestic purposes.
Harmonic emissions IEC 61000-3-2	Class A	
Voltage fluctuations/ Flicker emissions IEC 61000-3-3	Complies	



WARNING

Use of this equipment adjacent to or stacked with other equipment should be avoided because it could result in improper operation. If such use is necessary, this equipment and the other equipment should be observed to verify that they are operating normally.

5. Electromagnetic immunity declaration 1

Guidance and manufacturer's declaration – electromagnetic immunity			
The tbCOMPASS is intended for use in the electromagnetic environment specified below. The customer or user of the tbCOMPASS should ensure that it is used in such an environment.			
Immunity test	IEC 60601 test level	Compliance level	Electromagnetic environment - guidance
Electrostatic discharge (ESD) IEC 61000-4-2	±8 kV contact ±15 kV air	±8 kV contact ±15 kV air	Flooring should be wood, concrete, or ceramic tiles. If the floor is covered with synthetic material, the relative humidity should be at least 30%.
Electrical fast transient/burst IEC 61000-4-4	±2 kV for power supply lines ±1 kV for input/output lines	±2 kV for power supply lines ±1 kV for input/output lines	The mains power quality should be that of a typical commercial or hospital environment.
Surge IEC 61000-4-5	±1 kV differential mode ±2 kV common mode	±1 kV differential mode ±2 kV common mode	The mains power quality should be that of a typical commercial or hospital environment.
Voltage dips, short interruptions and voltage variations on power supply input lines IEC 61000-4-11	0% UT ; 0.5 cycles 0°, 45°, 90°, 135°, 180°, 225°, 270° and 315° 0% UT ; 1 cycle and 70% UT ; 25/30 cycles at 0°, single phase 0% UT ; 250/300 cycles	0% UT ; 0.5 cycles 0°, 45°, 90°, 135°, 180°, 225°, 270° and 315° 0% UT ; 1 cycle and 70% UT ; 25/30 cycles at 0°, single phase 0% UT ; 250/300 cycles	The mains power quality should be that of a typical commercial or hospital environment. If the user of the tbCOMPASS requires continued operation during mains power interruptions, it is recommended that the tbCOMPASS be powered from an uninterruptible power supply or a battery.
Power frequency (50/60 Hz) magnetic field IEC 61000-4-8	30 A/m	30 A/m	Power frequency magnetic fields should be at levels characteristic of a typical location in a typical commercial or hospital environment.
Note U_T is the AC mains voltage prior to the application of the test level.			

ELECTROMAGNETIC COMPATIBILITY (EMC)

6. Electromagnetic immunity declaration 2

Guidance and manufacturer's declaration – electromagnetic immunity			
The tbCOMPASS is intended for use in the electromagnetic environment specified below. The customer or user of the tbCOMPASS should ensure that it is used in such an environment.			
Immunity test	IEC 60601 test level	Compliance level	Electromagnetic environment - guidance
Conducted RF IEC 61000-4-6	3V 0.15MHz~80MHz 6V 0.15MHz~80MHz in ISM and amateur radio bands	3V 0.15MHz~80MHz 6V 0.15MHz~80MHz in ISM and amateur radio bands	Warning: Portable RF communications equipment (including peripherals such as antenna cables and external antennas) should be used no closer than 30 cm (12 inches) to any part of the tbCOMPASS, including cables specified by the manufacturer. Otherwise, degradation of the performance of this equipment could result.
Radiated RF IEC 61000-4-3	3V/m 80MHz~2.7GHz 80% AM (1 kHz)	3V/m 80MHz~2.7GHz 80% AM (1 kHz)	
Near electromagnetic field caused by RF wireless communication devices IEC 61000-4-3	See the table below	See the table below	

7. Essential performance

Unless operated by the chair control switch, the chair will not make any movements. Unless operated by the foot controller, the handpiece will not move except for sounding a buzzer and switching the indicator on/off. Loss or decline of essential performance may cause the chair or handpiece to move unexpectedly, causing harm to the patient, operator or people or objects around the patient or operator.

WARNING

Portable RF communications equipment (including peripherals such as antenna cables and external antennas) should be used no closer than 30 cm (12 inches) to any part of the tbCOMPASS, including cables specified by the manufacturer. Otherwise, degradation of the performance of this equipment could result.

Near electromagnetic field caused by RF wireless communication devices

Test frequency (MHz)	Modulation	IEC 60601 test level	IEC 60601 compliance level
385	Pulse modulation ^{a)} 18Hz	27V/m	27V/m
450	Frequency modulation ±5kHz shift 1kHz sine wave	28V/m	28V/m
710 745 780	Pulse modulation ^{a)} 217Hz	9V/m	9V/m
810 870 930	Pulse modulation ^{a)} 18Hz	28V/m	28V/m
1720 1845 1970	Pulse modulation ^{a)} 217Hz	28V/m	28V/m
2450	Pulse modulation ^{a)} 217Hz	28V/m	28V/m
5240 5500 5785	Pulse modulation ^{a)} 217Hz	9V/m	9V/m
Note a) The carrier is modulated by a square wave with a 50% duty cycle.			

DECLARATION OF CONFORMITY

We hereby declare that the product listed below complies with the essential requirements of the Medical Device Directive: 93/42/EEC and RoHS Directive: 2011/65/EU based on category 8 of Annex I.

Product : DENTAL UNIT AND CHAIR (CLASS IIa)

Model : tbCOMPASS

" CLASS IIa " has been defined by the rule 9 of MDD Annex IX.

The product has been designed and manufactured in accordance with the European standards as the listed in the Declaration of Conformity.

Our full quality assurance system has been approved to MDD ANNEX II, excluding section 4 (Registration No. HD 60143723 0001) by Notified Body, TUV Rheinland LGA Products GmbH (NO.0197).

NOTE

EC REP

TAKARA COMPANY EUROPE GmbH

Berner Strasse 18, 60437
Frankfurt am Main, Germany
Tel: +49 69 506878 0
Fax: +49 69 506878 20

 **Belmont**



TAKARA BELMONT CORPORATION

2-1-1, Higashishinsaibashi, Chuo-ku, Osaka, 542-0083, Japan
TEL : +81 6 6213 5945 FAX : +81 6 6212 3680